

# MISUTONIDA

italian style accessories **4x4**

## OPEL VIVARO-RENAULT TRAFIC



Item Code

Codice Articolo

Référence Article

**EC/MED/382/IX**

**EC/MED/383/IX**

**GB**

EC APPROVED STAINLESS STEEL  
MEDIUM BAR

**ITA**









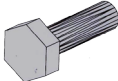

MEDIUM BAR OMOLOGATO  
IN ACCIAIO INOX

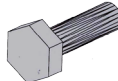
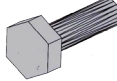
**FR**

MEDIUM BAR HOMOLOGUE  
EN ACCIER INOX

# OPEL VIVARO-RENAULT TRAFIC

Part List  
Lista della bulloneria  
Liste des pièces

<b>A</b>  <b>TE M8X20</b> x 6	<b>B</b>  <b>Ø 8</b> x 6	<b>C</b>  <b>Ø 8</b> x 8	<b>D</b>  <b>TE M8X25</b> x 2	<b>E</b>  <b>TE M6X25</b> x 2
<b>F</b>  <b>BIG Ø 6 GRANDE GRAND</b> x 2	<b>G</b>  <b>Ø 6</b> x 2	<b>H</b>  <b>M 6</b> x 2	<b>I</b>  <b>BIG Ø 8 GRANDE GRAND</b> x 2	<b>L</b>  <b>M/382/A</b> x 2
<b>M</b>  <b>M/382/B</b> x 2	<b>N</b>  <b>M/382/C</b> x 2	 <b>Cappelletti M8</b> x 4		

**lubricate the set of bolts  
supplied before tightening  
them**

**Lubrifier la boulonnerie fournie  
avant de la serrer**

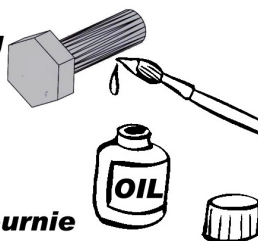

**Si consiglia di lubrificare  
la bulloneria in dotazione  
prima del settaggio**

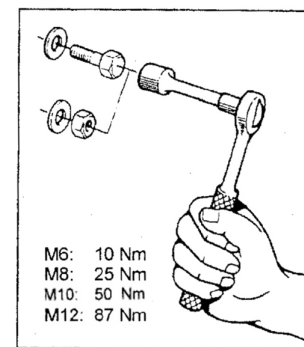

M6: 10 Nm  
M8: 25 Nm  
M10: 50 Nm  
M12: 87 Nm

# OPEL VIVARO-RENAULT TRAFIC

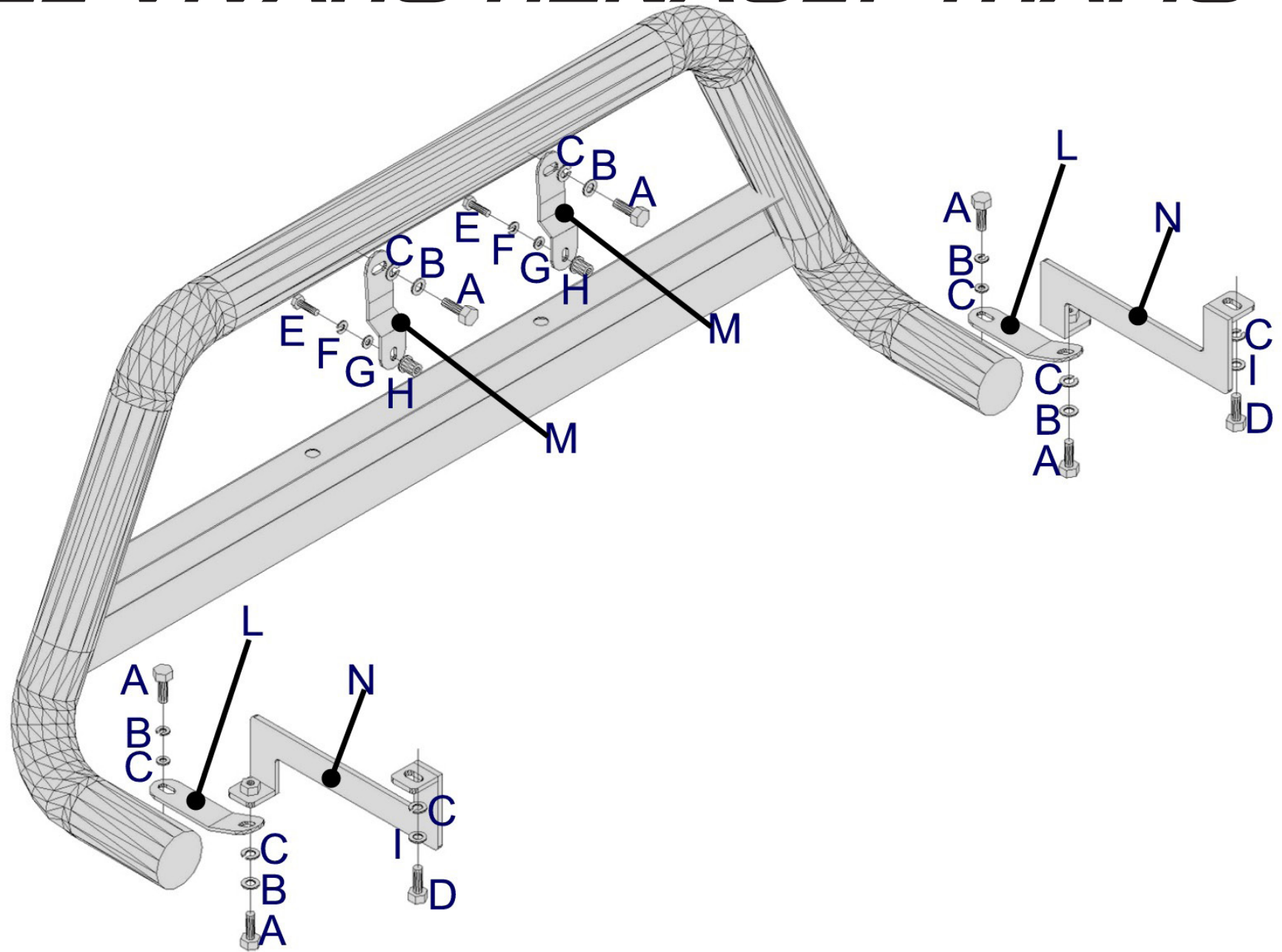

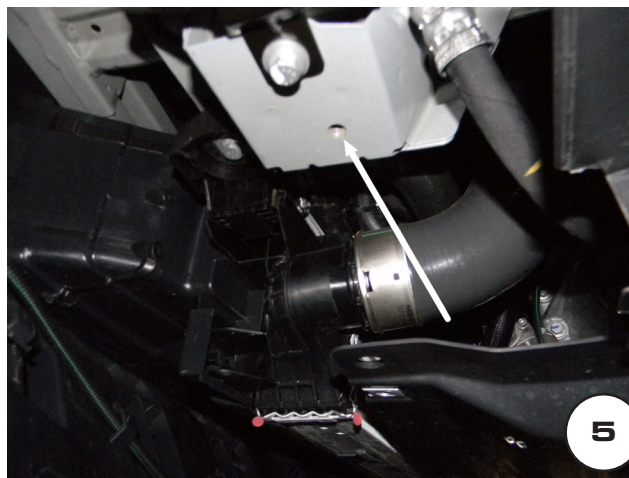
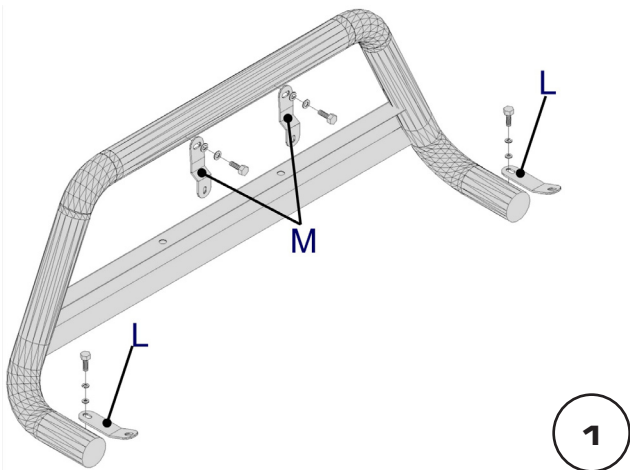

Date Data Date	Item Code Cod.Articolo Réf. Article	Vehicle model Modello Veicolo Modèle de Voiture
21/10/14	EC/MED/382/IX EC/MED/383/IX	OPEL VIVARO- RENAULT TRAFIC

**MISUTONIDA**  
 italian style accessories **4x4**

Document checked and approved by  
**Documento controllato ed approvato da**  
 Document contrôlé et approuvé par

**Botta  
 Pietro**

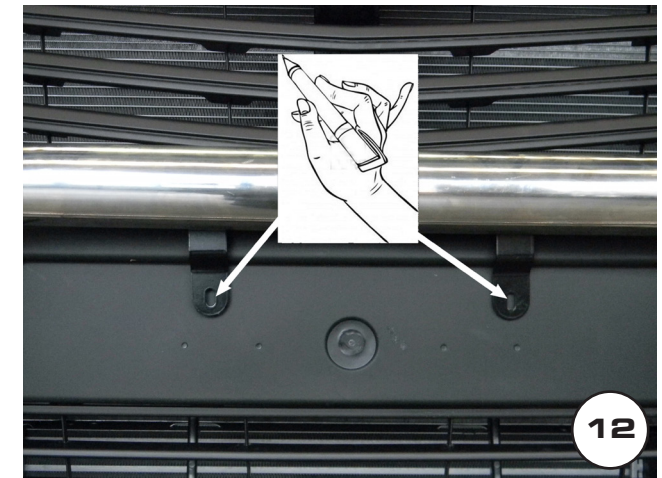
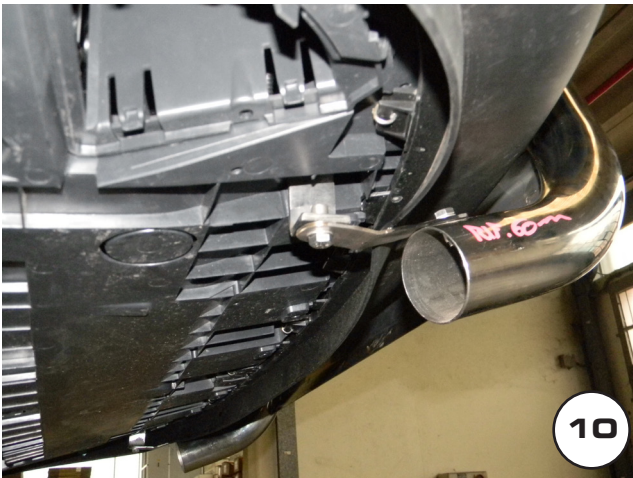
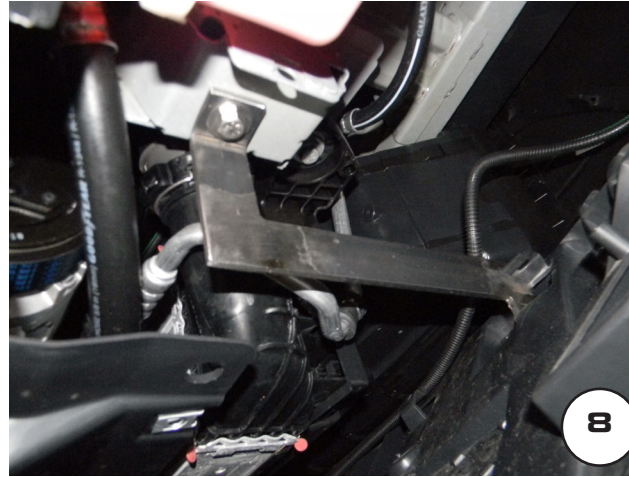
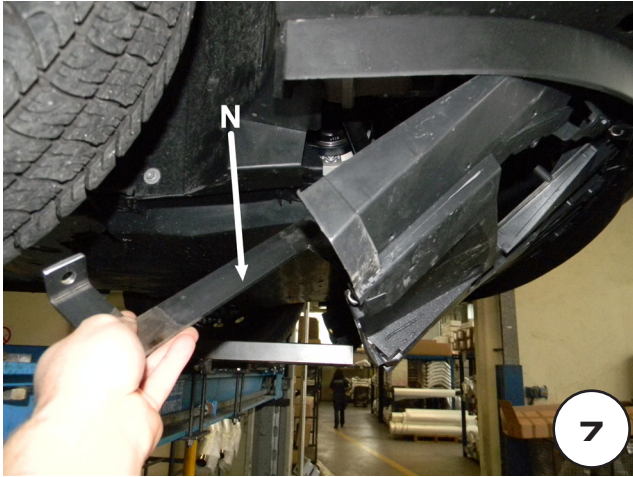

Date Data Date	Item Code Cod.Articolo Réf. Article	Vehicle model Modello Veicolo Modèle de Voiture
21/10/14	EC/MED/382/IX EC/MED/383/IX	OPEL VIVARO- RENAULT TRAFIC

**MISUTONIDA**  
italian style accessories **4x4**

Document checked and approved by  
**Documento controllato ed approvato da**  
Document contrôlé et approuvé par

**Botta**  
**Pietro**



**MISUTONIDA**  
 italian style accessories **4x4**

Date Data Date	Item Code Cod.Articolo Réf. Article	Vehicle model Modello Veicolo Modèle de Voiture
21/10/14	EC/MED/382/IX EC/MED/383/IX	OPEL VIVARO- RENAULT TRAFIC

Document checked and approved by  
**Documento controllato ed approvato da**  
*Document contrôlé et approuvé par*

**Botta**  
**Pietro**