

MISUTONIDA
italian style accessories **4x4**



ISUZU D-MAX 2020



40 Min.

Item Code

Codice Articolo EC/MED/480/IX

Reference Article

GB

**STAINLESS STEEL
 EC APPROVED MEDIUM BAR**











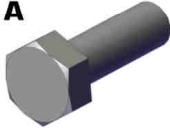

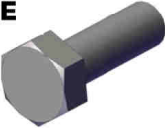
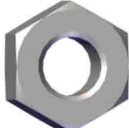
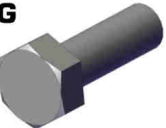

ITA

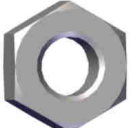
**MEDIUM BAR OMOLOGATO
 IN ACCIAIO INOX**

FR

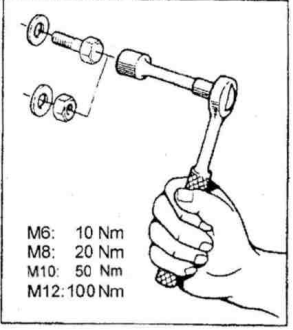
**MEDIUM BAR HOMOLOGUE
 EN ACCIER INOX**

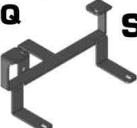
ISUZU D-MAX 2020

Part List Lista della bulloneria Liste des pièces														
A  TE M8X20 X 4	B  Ø 8 X 8	C  Ø 8 X 6	D  M 8 X 8	E  TE M8X20 WIPLA X 2	F  M 8 X 2	G  TE M6X25 X 2	H  Ø 6 Big Grandi Grand X 4	I  Ø 6 X 2	J  M 6 X 2	K  P/264/F X 2	L  Ø 10 Big Grandi Grand X 2	M  Ø 10 X 2	N  M 10 X 2	 <p>M6: 10 Nm M8: 20 Nm M10: 50 Nm M12: 100 Nm</p>
O  SM/480/A X 2	P  SM/480/B X 2	Q  SMA/480/A X 1	R  STICKERS PARK SENSORS X 2											



MISUTONIDA
italian style accessories **4x4**

ISUZU D-MAX 2020

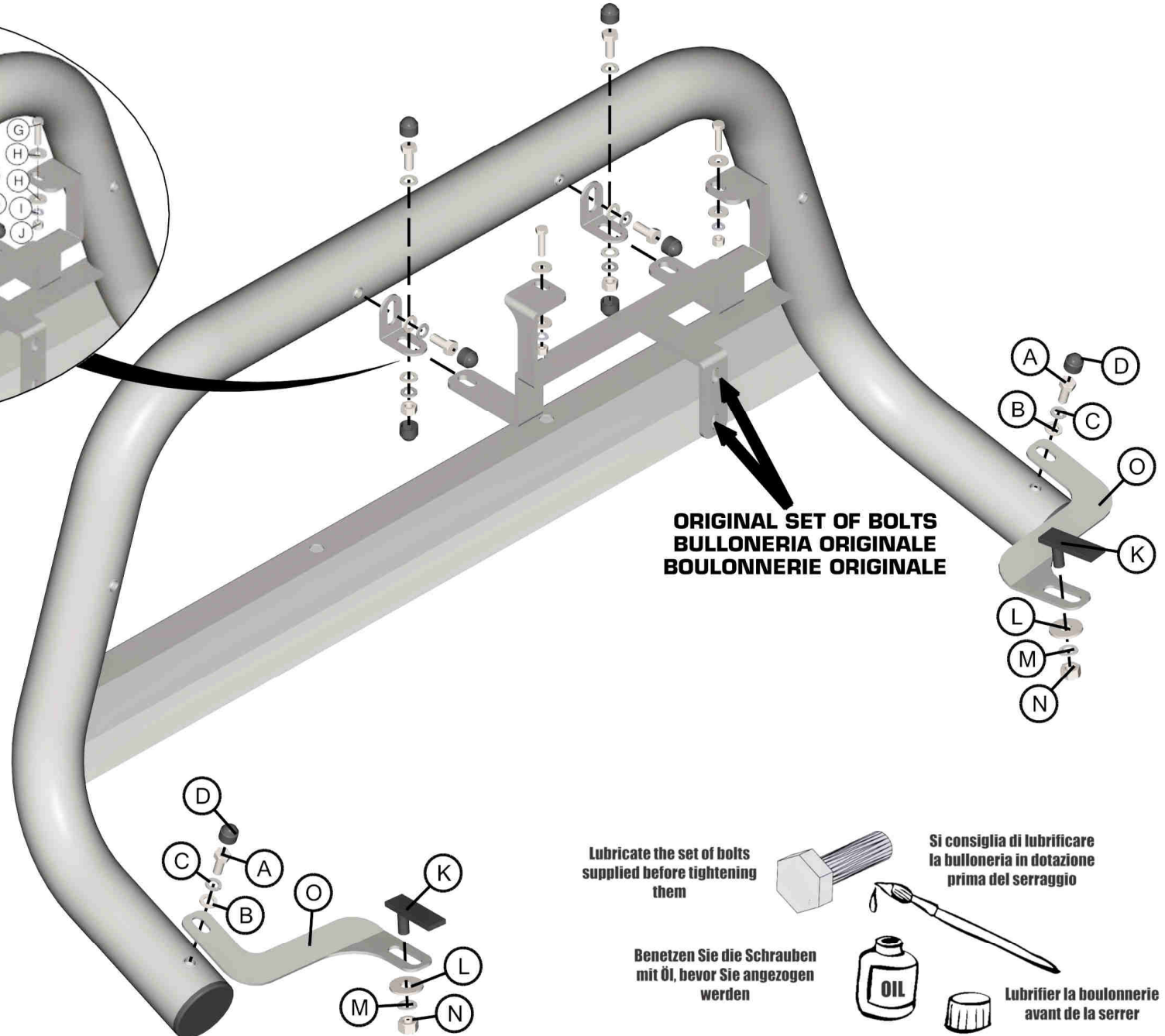
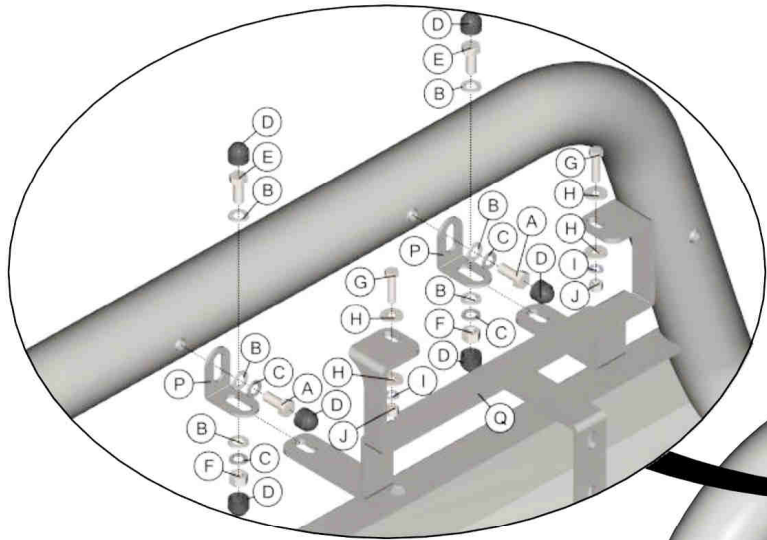

Lubricate the set of bolts
supplied before tightening
them

Benetzen Sie die Schrauben
mit Öl, bevor Sie angezogen
werden

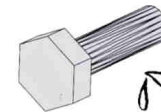

Si consiglia di lubrificare
la bulloneria in dotazione
prima del serraggio



Lubrifier la boulonnerie
avant de la serrer

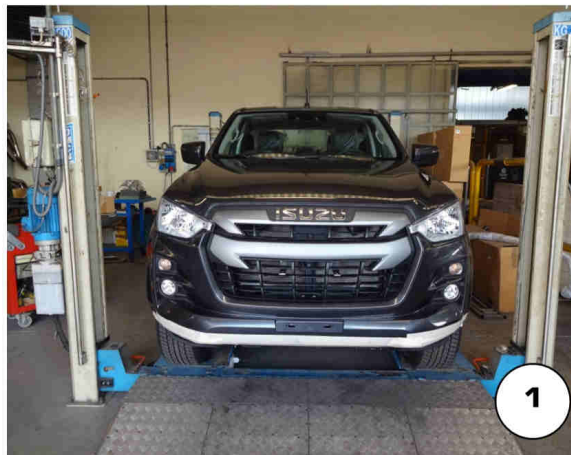

1

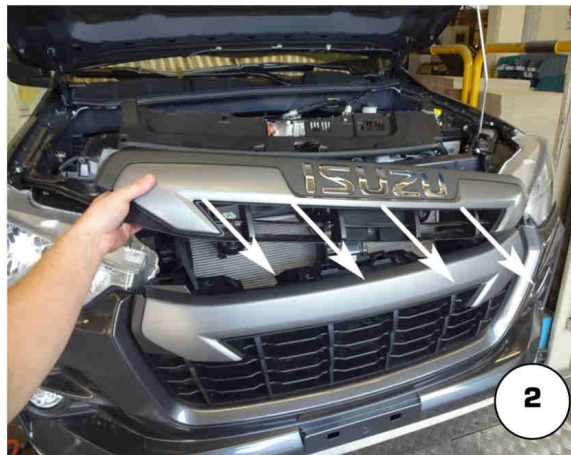

2

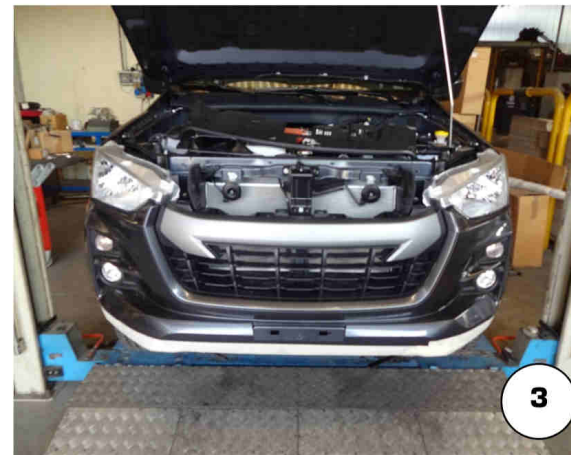

3



4



5



6

Date Data Date	Item Code Cod. Articolo Réf. Article	Vehicle model Modello Veicolo Modèle de Voiture
29/09/2020	EC/MED/480/IX	ISUZU D-MAX 2020

Document checked and approved by
Documento controllato ed approvato da
 Document contrôlé et approuvé par

BOTTA PIETRO

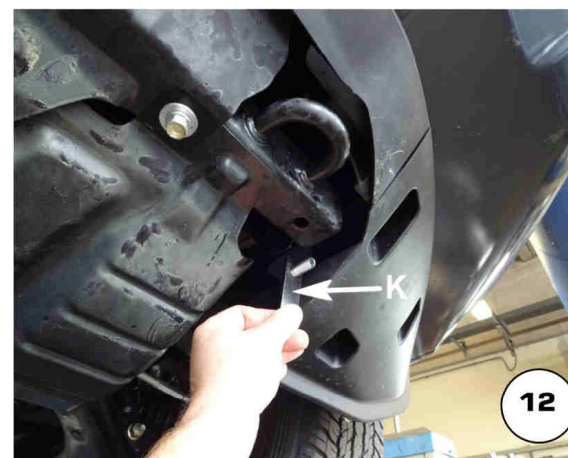
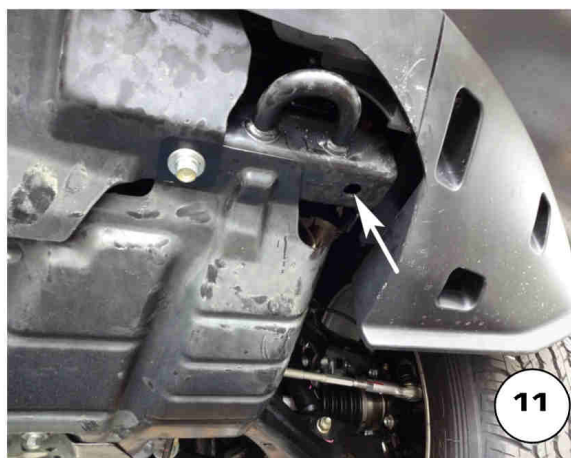
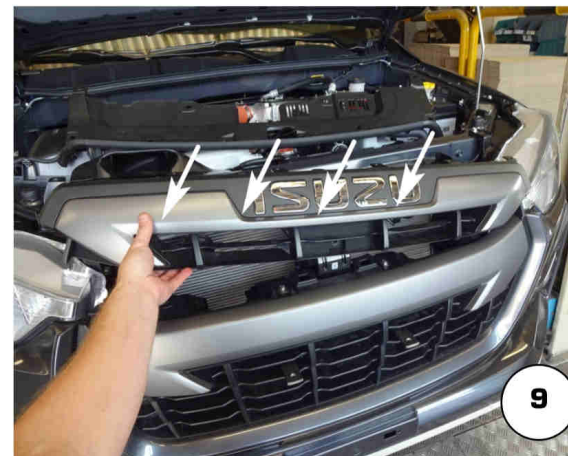

Date Data Date	Item Code Cod. Articolo Réf. Article	Vehicle model Modello Veicolo Modèle de Voiture
29/09/2020	EC/MED/480/IX	ISUZU D-MAX 2020

Document checked and approved by
 Documento controllato ed approvato da
 Document contrôlé et approuvé par

BOTTA PIETRO

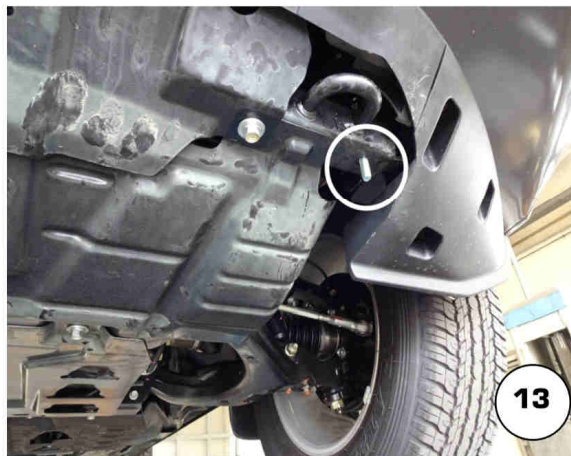

13

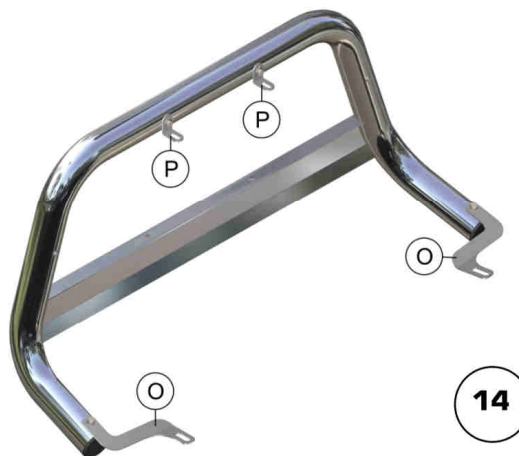

14

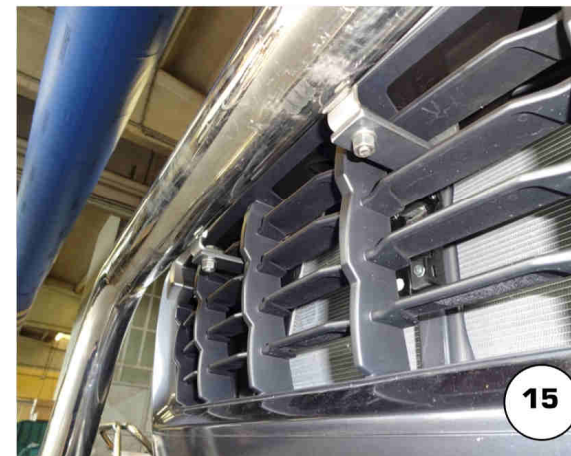

15

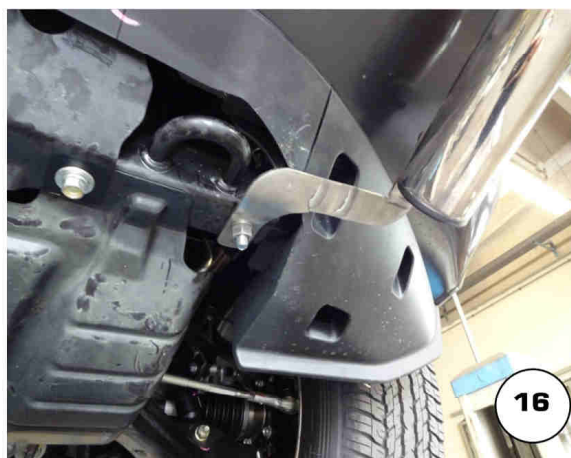

16



17



18

Date Data Date	Item Code Cod. Articolo Réf. Article	Vehicle model Modello Veicolo Modèle de Voiture
29/09/2020	EC/MED/480/IX	ISUZU D-MAX 2020

Document checked and approved by
 Documento controllato ed approvato da
 Document contrôlé et approuvé par

BOTTA PIETRO