

# MISUTONIDA

italian style accessories 4x4



## ISUZU D-MAX 2024



**40 Min.**

Item Code

**Codice Articolo EC/MED/540/IX**

Référence Article

**GB**

STAINLESS STEEL  
EC APPROVED MEDIUM BAR











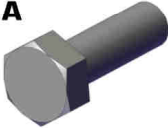

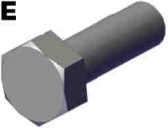
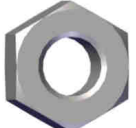
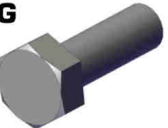

**ITA**

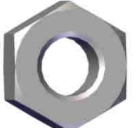
MEDIUM BAR OMOLOGATO  
IN ACCIAIO INOX

**FR**

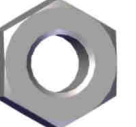
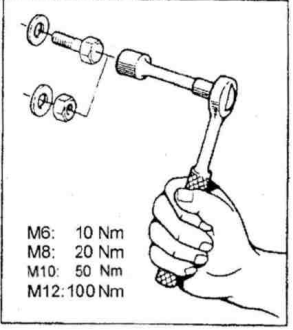
MEDIUM BAR HOMOLOGUE  
EN ACCIER INOX

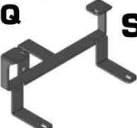
# ISUZU D-MAX 2024

Part List Lista della bulloneria Liste des pièces														
<b>A</b>  <b>TE M8X20</b> X 4	<b>B</b>  <b>Ø 8</b> X 8	<b>C</b>  <b>Ø 8</b> X 6	<b>D</b>  <b>M 8</b> X 8	<b>E</b>  <b>TE M8X20 WIPLA</b> X 2	<b>F</b>  <b>M 8</b> X 2	<b>G</b>  <b>TE M6X25</b> X 2	<b>H</b>  <b>Ø 6</b> Big Grandi Grand X 4	<b>I</b>  <b>Ø 6</b> X 2	<b>J</b>  <b>M 6</b> X 2	<b>K</b>  <b>P/264/F</b> X 2	<b>L</b>  <b>Ø 10</b> Big Grandi Grand X 2	<b>M</b>  <b>Ø 10</b> X 2	<b>N</b>  <b>M 10</b> X 2	 <p>M6: 10 Nm M8: 20 Nm M10: 50 Nm M12: 100 Nm</p>
<b>O</b>  <b>SB/480/A</b> X 2	<b>P</b>  <b>SM/480/B</b> X 2	<b>Q</b>  <b>SMA/480/A</b> X 1	<b>R</b>  <b>STICKERS PARK SENSORS</b> X 2											



# ISUZU D-MAX 2024

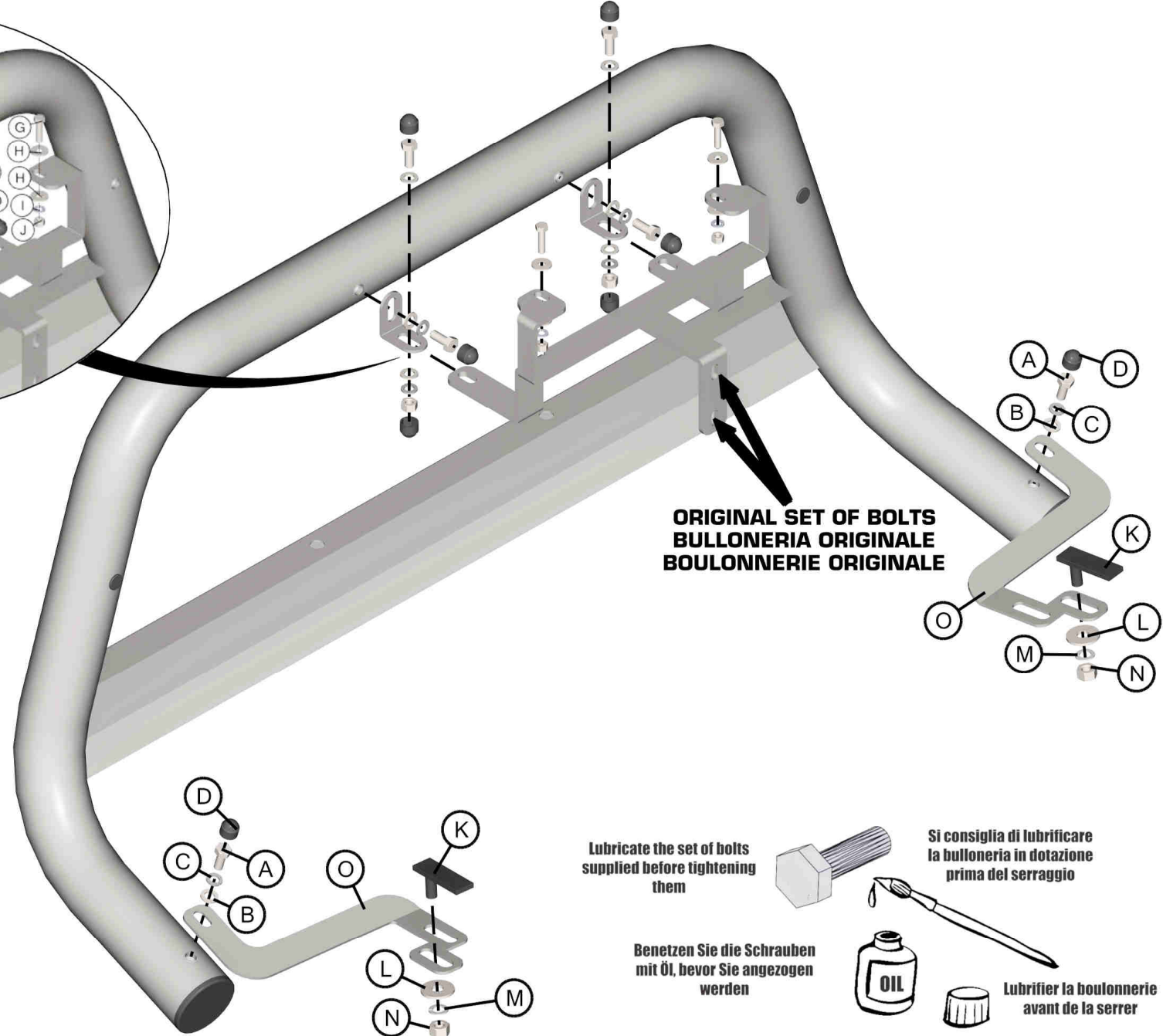
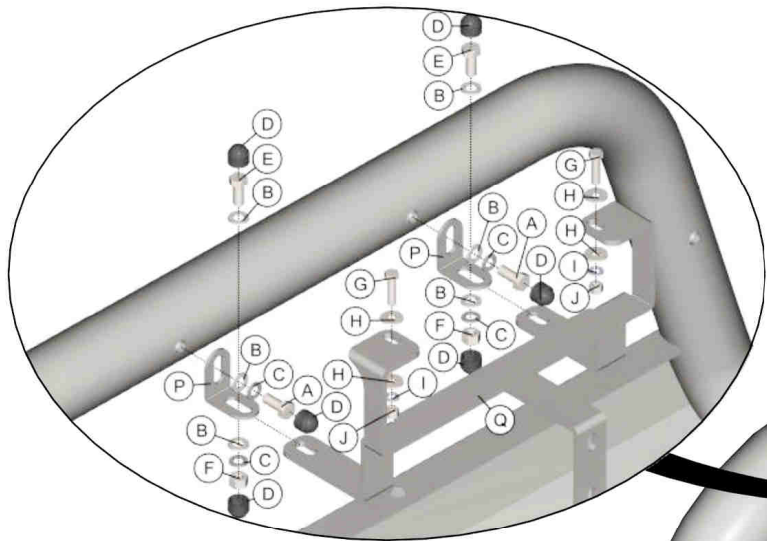

**ORIGINAL SET OF BOLTS  
BULLONERIA ORIGINALE  
BOULONNERIE ORIGINALE**

Lubricate the set of bolts  
supplied before tightening  
them

Benetzen Sie die Schrauben  
mit Öl, bevor Sie angezogen  
werden

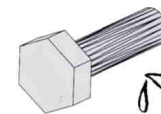

Si consiglia di lubrificare  
la bulloneria in dotazione  
prima del serraggio



Lubrifier la boulonnerie  
avant de la serrer

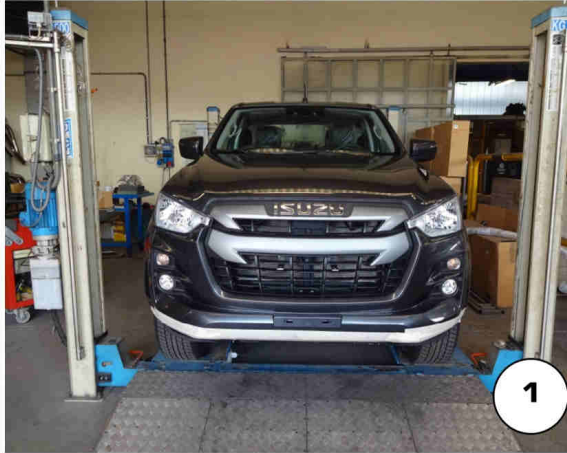

1



2



3



4



5



6

Date Data Date	Item Code Cod. Articolo Réf. Article	Vehicle model Modello Veicolo Modèle de Voiture
07/11/2024	EC/MED/540/IX	ISUZU D-MAX 2024

Document checked and approved by  
**Documento controllato ed approvato da**  
 Document contrôlé et approuvé par

**BOTTA PIETRO**

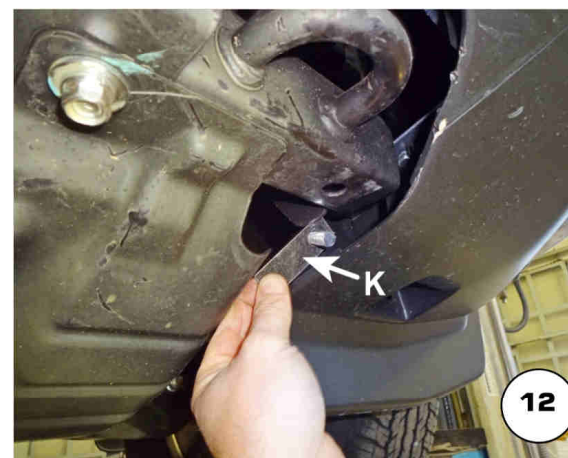
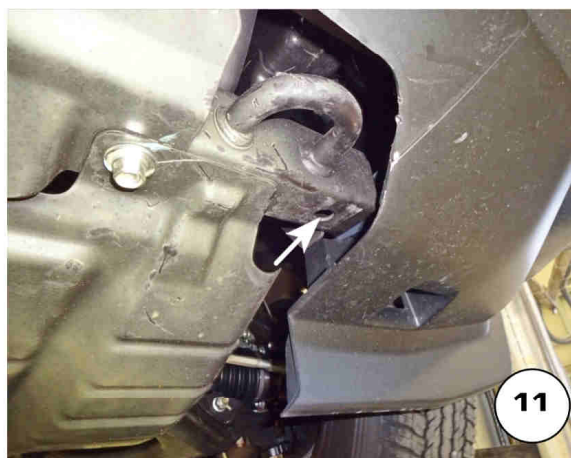
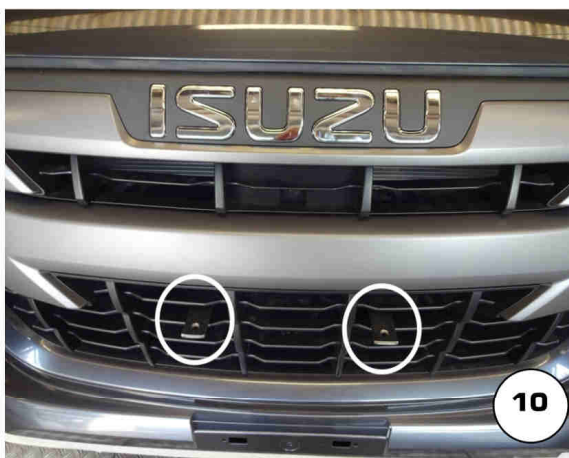
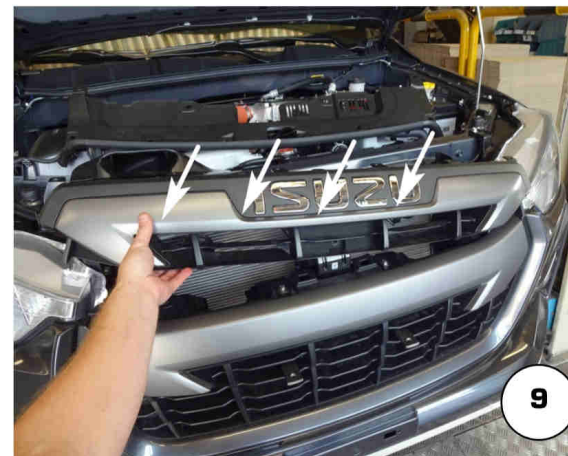

Date Data Date	Item Code Cod. Articolo Réf. Article	Vehicle model Modello Veicolo Modèle de Voiture
07/11/2024	EC/MED/540/IX	ISUZU D-MAX 2024

Document checked and approved by  
 Documento controllato ed approvato da  
 Document contrôlé et approuvé par

**BOTTA PIETRO**

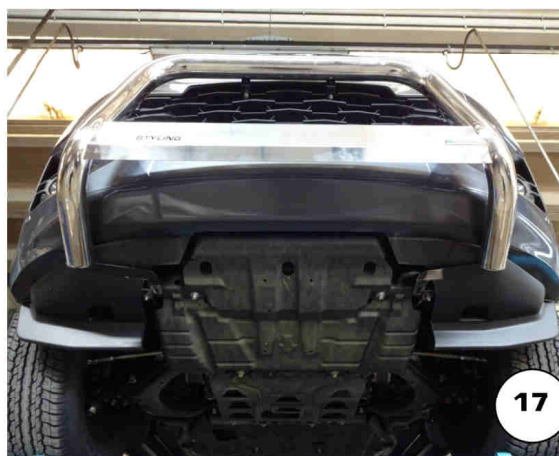
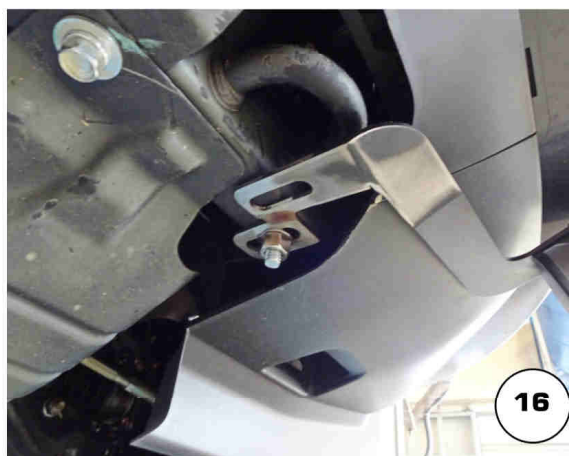
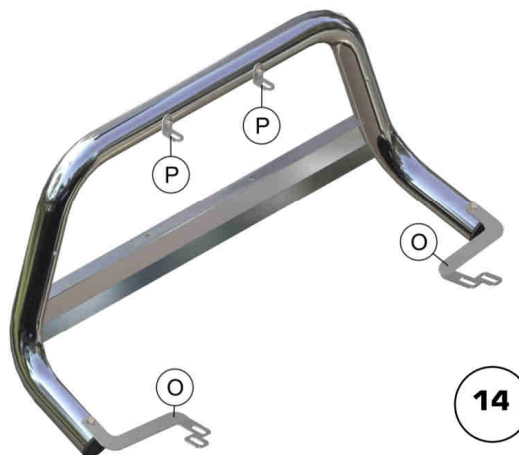
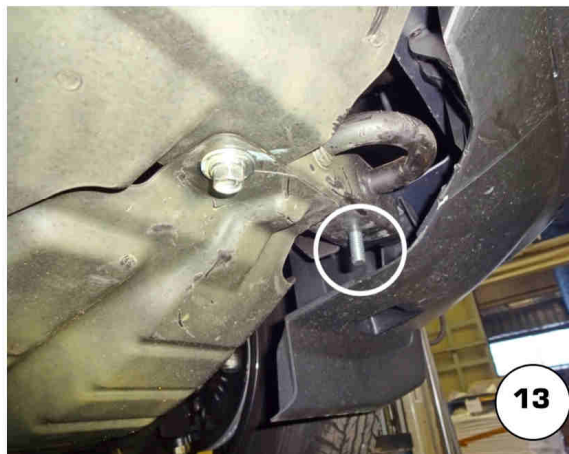

Date Data Date	Item Code Cod. Articolo Réf. Article	Vehicle model Modello Veicolo Modèle de Voiture
07/11/2024	EC/MED/540/IX	ISUZU D-MAX 2024

Document checked and approved by  
 Documento controllato ed approvato da  
 Document contrôlé et approuvé par

**BOTTA PIETRO**