

**MISUTONIDA**  
 italian style accessories **4x4**



## RENAULT MASTER 2019



**50 Min.**

Item Code

**Codice Articolo EC/MED/464/IX**

Référence Article

**GB**

STAINLESS STEEL  
EC APPROVED MEDIUM BAR











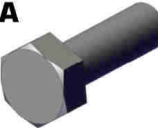



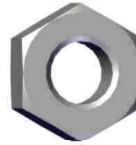

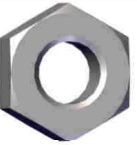

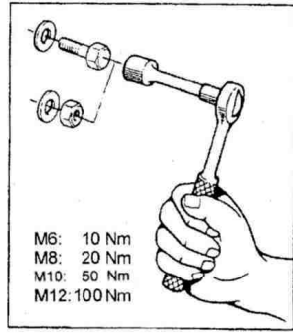

**ITA**

MEDIUM BAR OMOLOGATO  
IN ACCIAIO INOX

**FR**

MEDIUM BAR HOMOLOGUE  
EN ACCIER INOX

# RENAULT MASTER 2019

Part List Lista della bulloneria Liste des pièces					
<b>A</b>  <b>TE M8X20</b> X 4	<b>B</b>  <b>Ø 8</b> X 8	<b>C</b>  <b>Ø 8</b> X 8	<b>D</b>  <b>M 8</b> X 8	<b>E</b>  <b>TE M8X20 WIPLA</b> X 2	
<b>F</b>  <b>M 8</b> X 2	<b>G</b>  <b>TE M8X40</b> X 2	<b>H</b>  <b>BOCCOLA 145</b> X 2	<b>I</b>  <b>M 10</b> X 2	<b>J</b>  <b>Ø 10</b> Big Grandi Grand X 2	
<b>K</b>  <b>Ø 10</b> X 2	<b>L</b>  <b>P/342/E</b> X 2	<b>M</b>  <b>TE M6X60</b> X 2	<b>N</b>  <b>Ø 6</b> Big Grandi Grand X 2	 <p>M6: 10 Nm M8: 20 Nm M10: 50 Nm M12: 100 Nm</p>	
<b>O</b>  <b>Ø 6</b> X 2	<b>P</b>  <b>BOCCOLA AB/201</b> X 2	<b>Q</b>  <b>M/464/A</b> X 2	<b>R</b>  <b>M/464/B</b> X 2		
<b>S</b>  <b>M/464/C</b> X 1	<b>T</b>  <b>M/464/D</b> X 1	<b>U</b>  <b>M/464/E</b> X 2			



Approval mark below the central plate

**MISUTONIDA**  
italian style  
accessories **4x4**

# RENAULT MASTER 2019

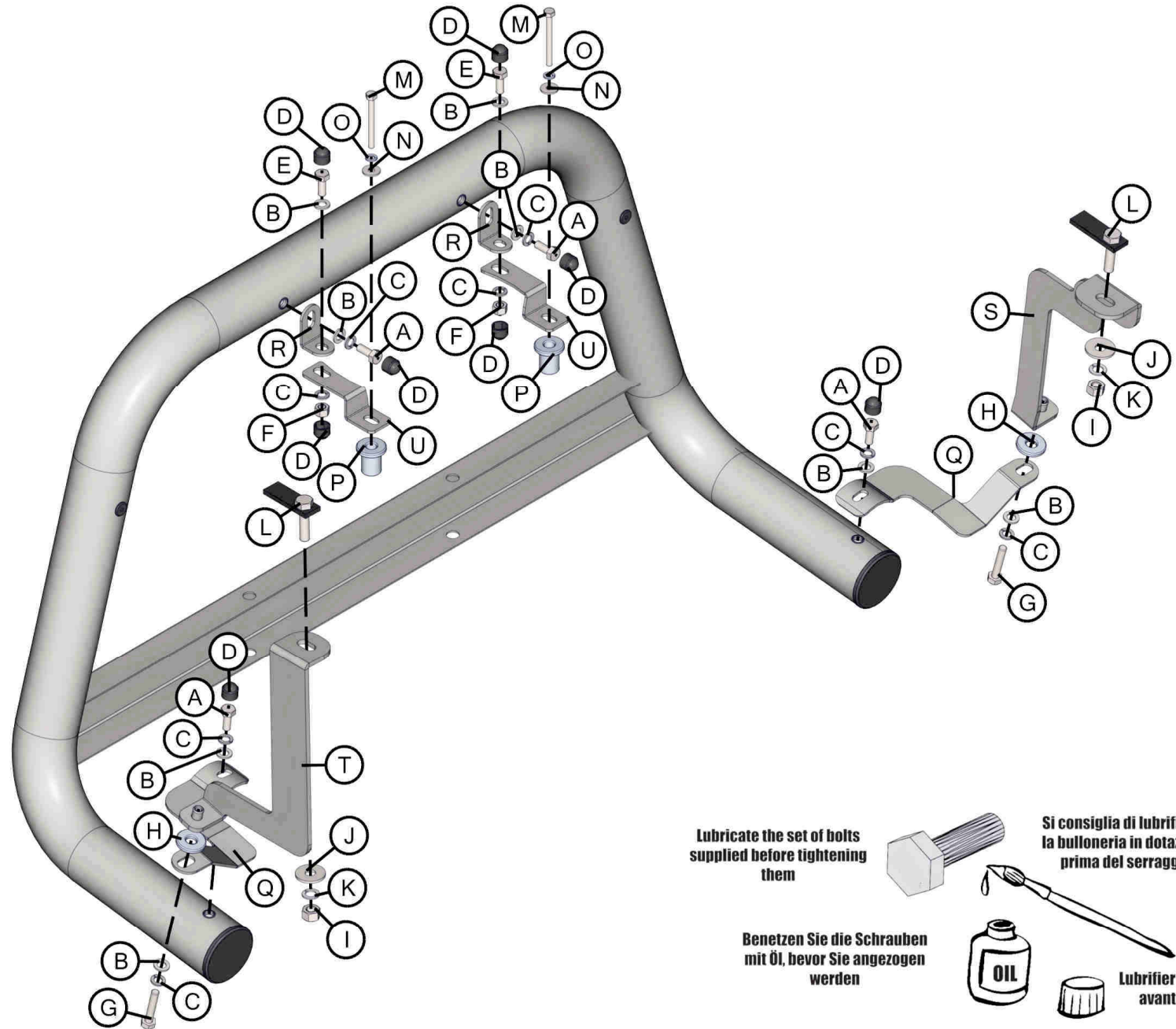

Lubricate the set of bolts  
supplied before tightening  
them

Benetzen Sie die Schrauben  
mit Öl, bevor Sie angezogen  
werden

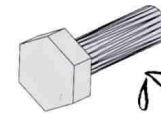

Si consiglia di lubrificare  
la bulloneria in dotazione  
prima del serraggio



Lubrifier la boulonnerie  
avant de la serrer

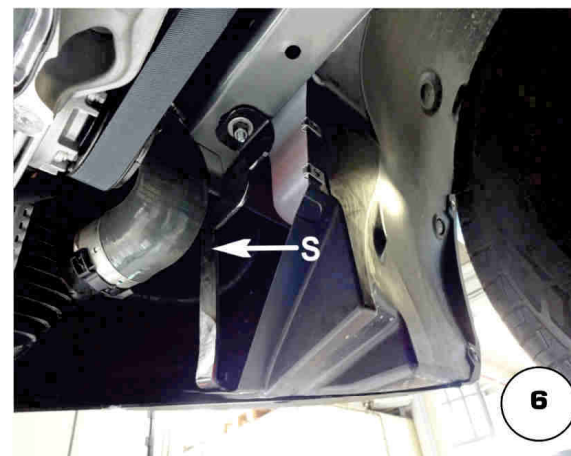
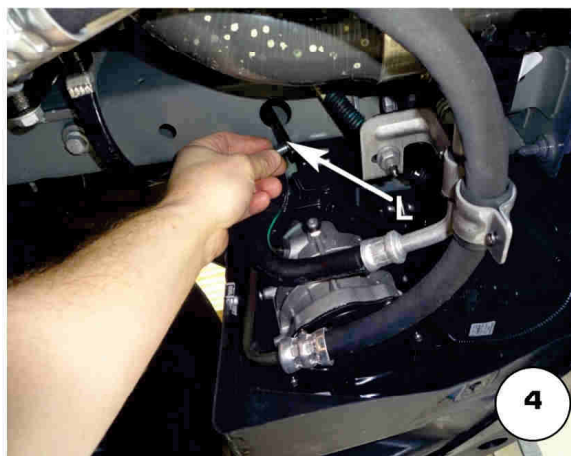
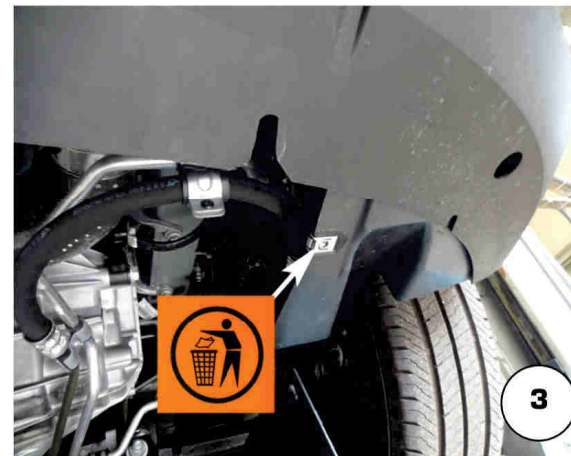

Date Data Date	Item Code Cod. Articolo Réf. Article	Vehicle model Modello Veicolo Modèle de Voiture
12/11/2019	EC/MED/464/IX	RENAULT MASTER 2019

Document checked and approved by  
**Documento controllato ed approvato da**  
 Document contrôlé et approuvé par

**BOTTA PIETRO**

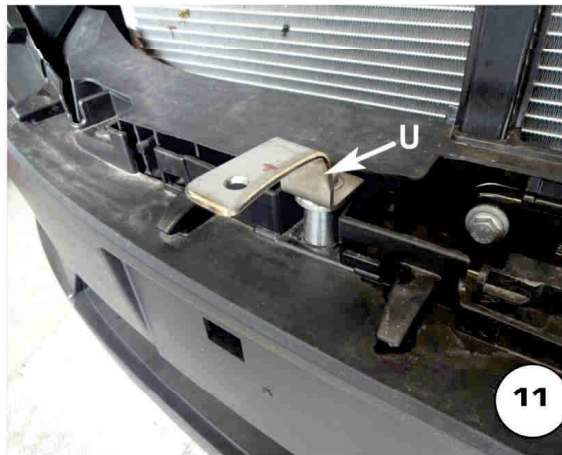
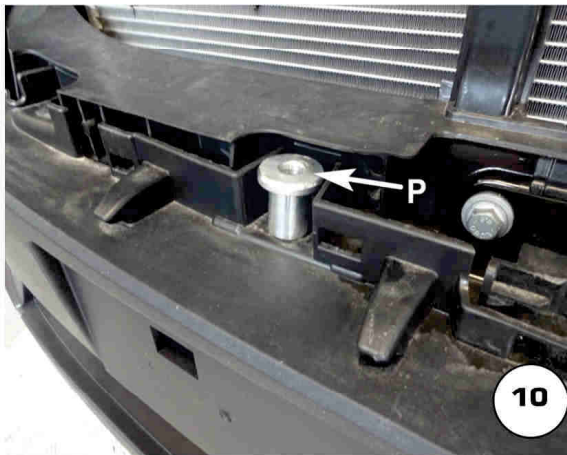
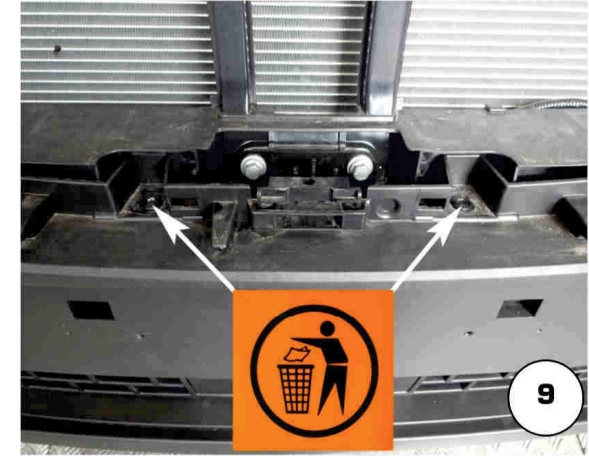

Date Data Date	Item Code Cod. Articolo Réf. Article	Vehicle model Modello Veicolo Modèle de Voiture
12/11/2019	EC/MED/464/IX	RENAULT MASTER 2019

Document checked and approved by  
 Documento controllato ed approvato da  
 Document contrôlé et approuvé par

**BOTTA PIETRO**

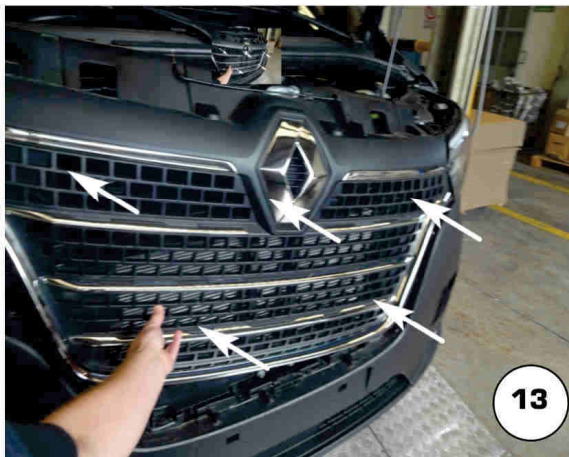

13

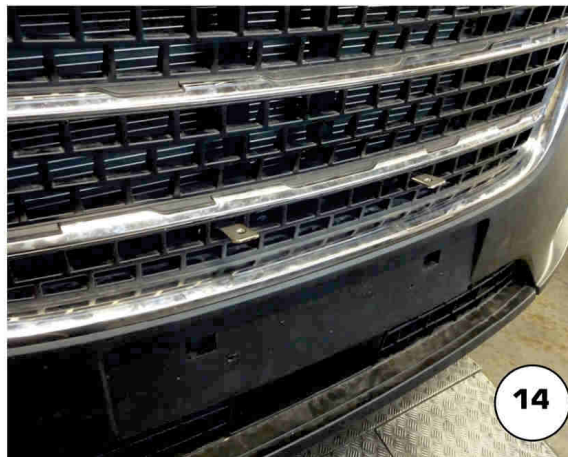

14

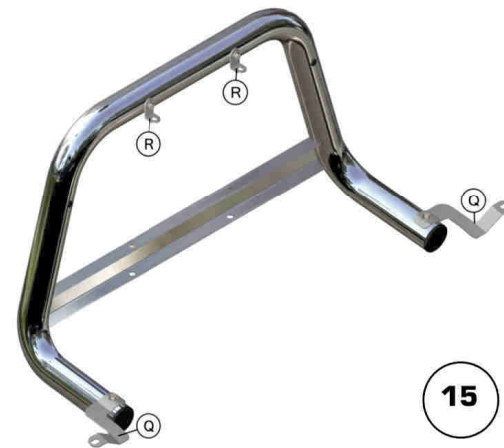

15

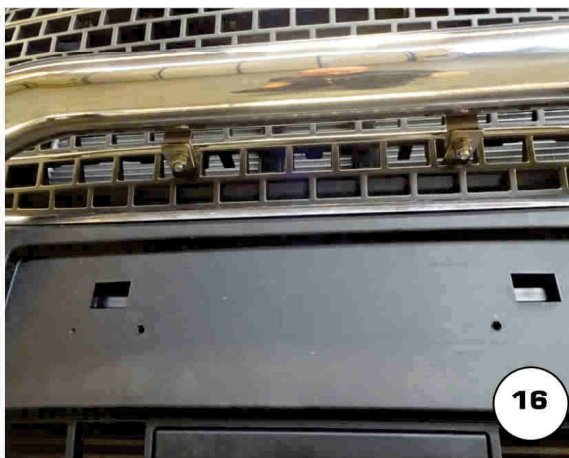

16



17

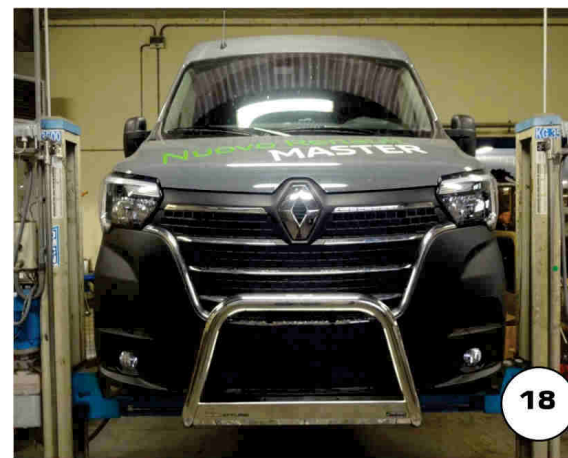

18

Date Data Date	Item Code Cod. Articolo Réf. Article	Vehicle model Modello Veicolo Modèle de Voiture
12/11/2019	EC/MED/464/IX	RENAULT MASTER 2019

Document checked and approved by  
**Documento controllato ed approvato da**  
 Document contrôlé et approuvé par

**BOTTA PIETRO**