

MISUTONIDA
italian style accessories **4x4**

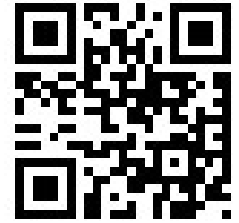

**TOYOTA HI-LUX DOUBLE CAB
 2016**



60 Min.

Item Code

Codice Articolo

: EC/MED/410/IX

Référence Article

GB

STAINLESS STEEL
 EC APPROVED MEDIUM BAR

ITA









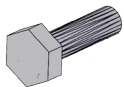

MEDIUM BAR OMOLOGATO
 IN ACCIAIO INOX

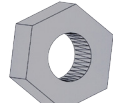
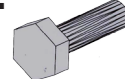
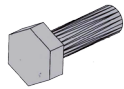
FR

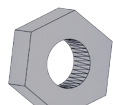
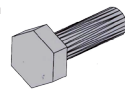
MEDIUM BAR HOMOLOGUE
 EN ACCIER INOX

TOYOTA HI-LUX DOUBLE CAB 2016

Part List
Lista della bulloneria
Liste des pièces

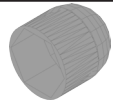
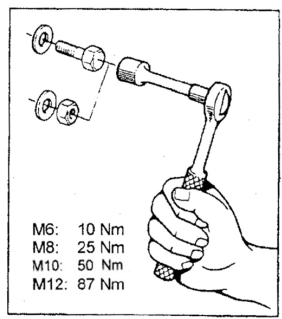
| | | | | |
|--|--|---|---|---|
| A  TE 8X20 x 4 | B  Ø 8 x 6 | C  Ø 8 x 6 | D  M 8 x 2 | E  M8X20 DIN 933/931 COLORE NATURALE x 2 |
| F  TE 10X90 x 4 | G  Ø 10 x 4 | H  Ø 10 x 4 | I  M 10 x 4 | L  TE 12X25 P 1.25 P 1.25 P 1.15 x 2 |
| M  Ø 12 x 2 | N  Ø 12 x 2 | O  M/410/F x 2 | P  SM/410/B x 2 | Q  SM/410/C x 2 |
| R  SMA/410/A x 2 |  Cappelletti M8 x 8 | | | |
| | | | |  <p>M6: 10 Nm M8: 25 Nm M10: 50 Nm M12: 87 Nm</p> |

TOYOTA HILUX DOUBLE CAB 2016

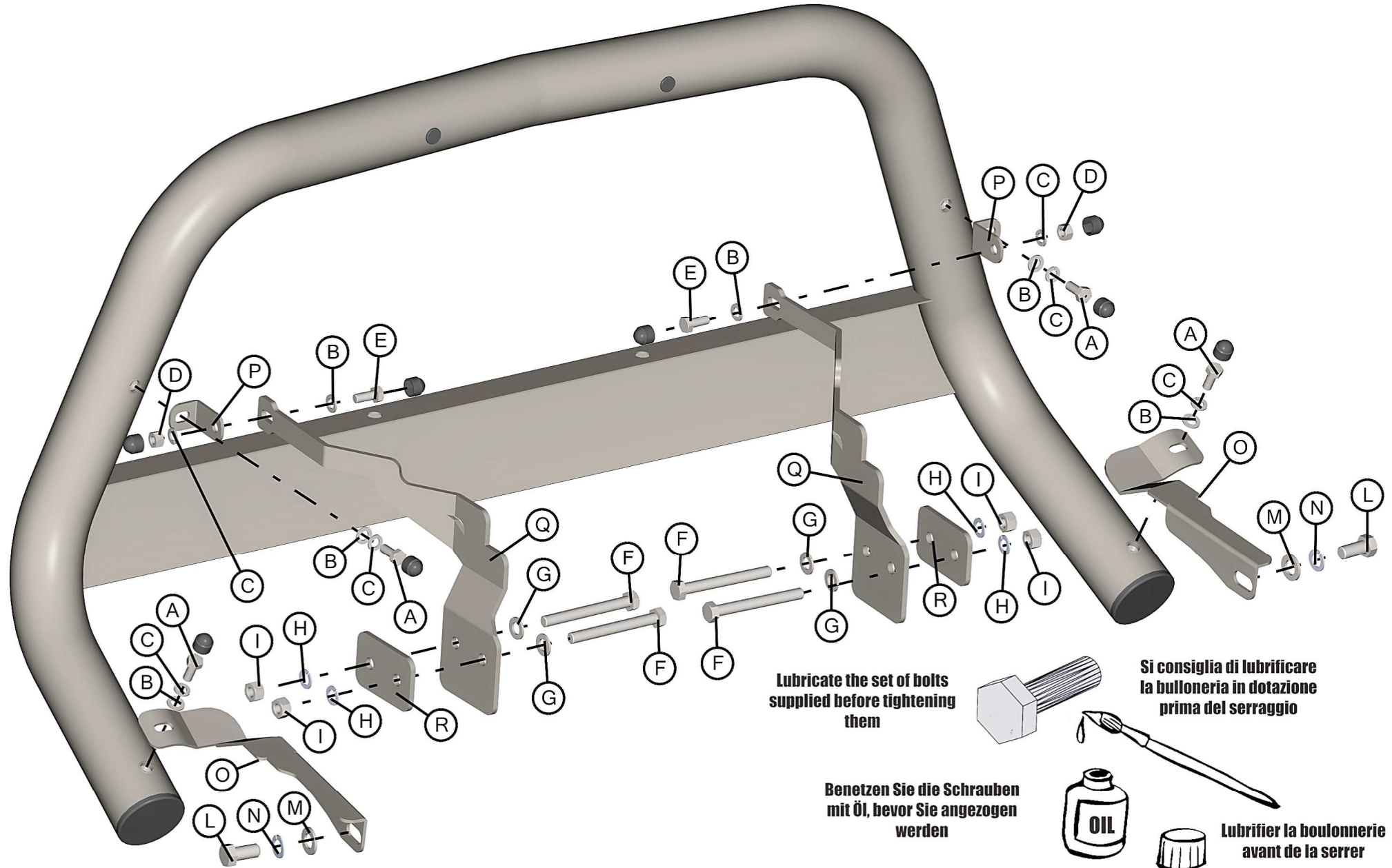

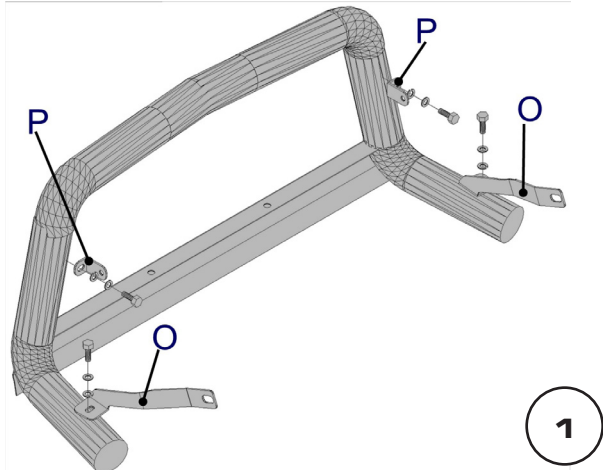

| Date Data Date | Item Code Cod.Articolo Réf. Article | Vehicle model Modello Veicolo Modèle de Voiture |
|----------------------|---|---|
| 27/05/16 | EC/MED/410/IX | HI-LUX DOUBLE CAB 2016 |

MISUTONIDA
italian style accessories **4x4**

Document checked and approved by
Documento controllato ed approvato da
 Document contrôlé et approuvé par

BOTTA PIETRO

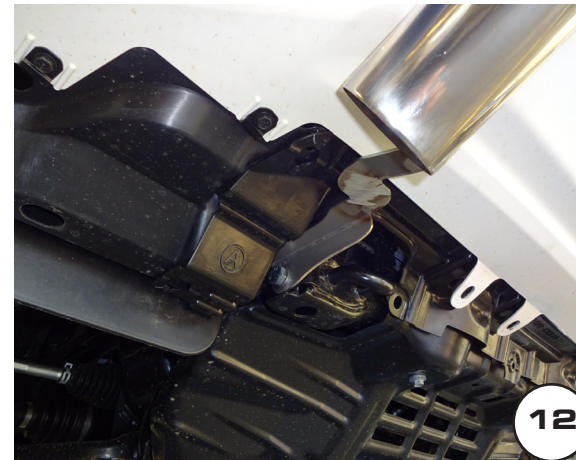

| Date Data Date | Item Code Cod.Articolo Réf. Article | Vehicle model Modello Veicolo Modèle de Voiture |
|----------------------|---|---|
| 27/05/16 | EC/MED/410/IX | HI-LUX DOUBLE CAB 2016 |

Document checked and approved by
Documento controllato ed approvato da
 Document contrôlé et approuvé par

BOTTA PIETRO

MISUTONIDA
 italian style accessories **4x4**

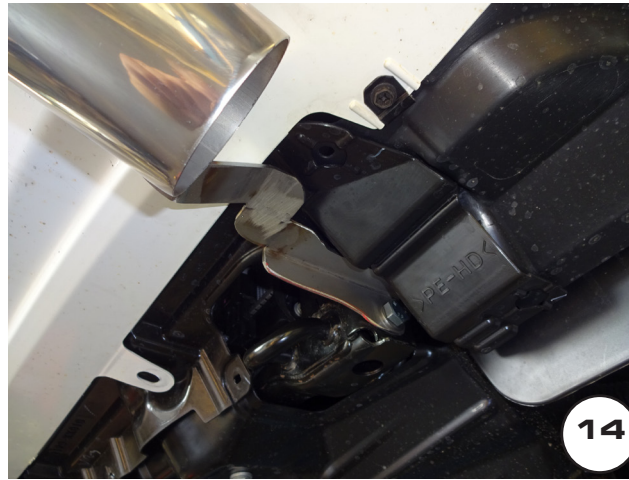
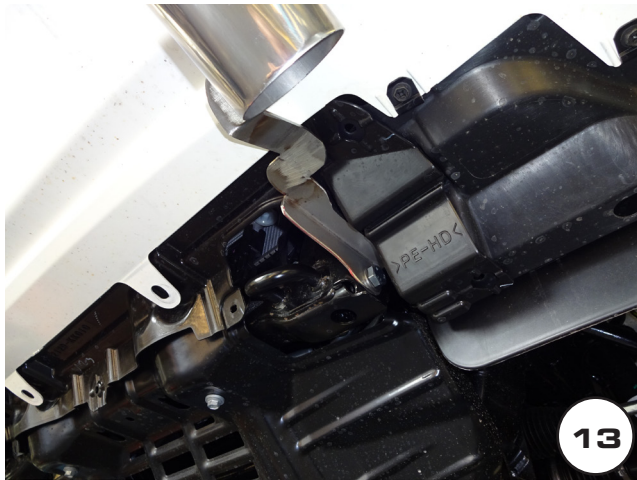

| Date Data Date | Item Code Cod.Articolo Réf. Article | Vehicle model Modello Veicolo Modèle de Voiture |
|----------------------|---|---|
| 27/05/16 | EC/MED/410/IX | HI-LUX DOUBLE CAB 2016 |

MISUTONIDA
italian style accessories **4x4**

Document checked and approved by
Documento controllato ed approvato da
Document contrôlé et approuvé par

BOTTA PIETRO

TOYOTA HI-LUX INVICTUS DOUBLE CAB 2016



GB

WARNING: for the correct fitting of the SM/410/C brackets (Q) on the INVICTUS model you need to cut the plastic grill in the position shown in the picture

ITA

ATTENZIONE: sul modello INVICTUS per il corretto fissaggio delle staffe SM/410/C (Q) è necessario tagliare la griglia in plastica nel punto indicato nella foto

FR

ATTENTION: pour le correct montage des pattes de fixation SM/410/C (Q) sur la version INVICTUS il est nécessaire de couper la grille en plastique dans la position indiquée dans la photo

| Date Data Date | Item Code Cod.Articolo Réf. Article | Vehicle model Modello Veicolo Modèle de Voiture |
|----------------------|---|---|
| 27/05/16 | EC/MED/410/IX | HI-LUX DOUBLE CAB 2016 |

MISUTONIDA
italian style accessories **4x4**

Document checked and approved by
Documento controllato ed approvato da
Document contrôlé et approuvé par

BOTTA PIETRO