

# MISUTONIDA

italian style accessories 4x4



## ISUZU D-MAX 2026



**50 Min.**

Item Code

**Codice Articolo EC/MED/560/PL**

Référence Article

**GB**

STAINLESS STEEL MEDIUM  
BAR

**ITA**









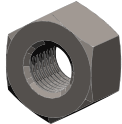
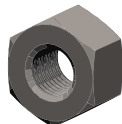
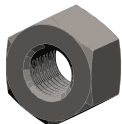
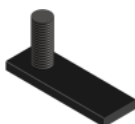

**MEDIUM BAR IN ACCIAIO  
INOX**

**FR**

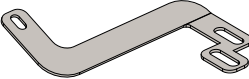
MEDIUM BAR EN ACCIER  
INOX

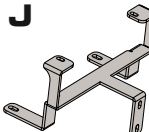
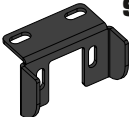
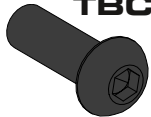
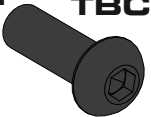
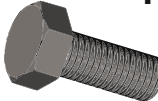
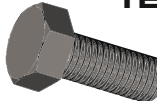
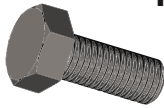
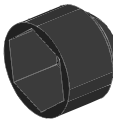
# ISUZU D-MAX 2026

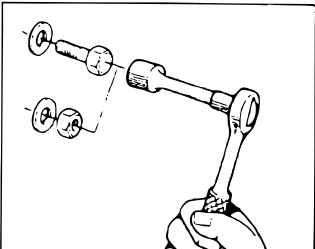
Part list  
**Lista Bulloneria**  
 Liste des pièces

<b>A</b>  <b>M10</b> x 2	<b>B</b>  <b>M6</b> x 4	<b>C</b>  <b>M8</b> x 2	<b>D</b>  <b>P/264/F</b> x 2	<b>E</b>  <b>Ø8</b> x 8
<b>F</b>  Big Grandi Grand <b>Ø10</b> x 2	<b>G</b>  Big Grandi Grand <b>Ø6</b> x 6	<b>H</b>  <b>SB/480/A</b> x 2	<b>I</b>  <b>SM/480/B</b> x 2	<b>J</b>  <b>SMA/480/A</b> x 1
<b>K</b>  <b>SMA/560/A</b> x 1	<b>L</b>  <b>TBCEI M6x20</b> x 2	<b>M</b>  <b>TBCEI M8x25</b> x 2	<b>N</b>  <b>TE M6X25</b> x 2	<b>O</b>  <b>TE M8X20</b> x 4
<b>P</b>  <b>TE M8X20 WIPLA</b> x 2	<b>Q</b>  <b>M8</b> x 8	<b>R</b>  <b>Ø10</b> x 2	<b>S</b>  <b>Ø8</b> x 6	 <p>M6: 10 Nm                  M8: 25 Nm                  M10: 50 Nm                  M12: 87 Nm</p>
<b>T</b>  <b>Ø6</b> x 4	<b>U</b>  <b>STICKERS PARK SENSORS Ø16</b> x 2			



Approval Mark below the central plate

**MISUTONIDA**  
 italian style accessories **4x4**

# ISUZU D-MAX 2026

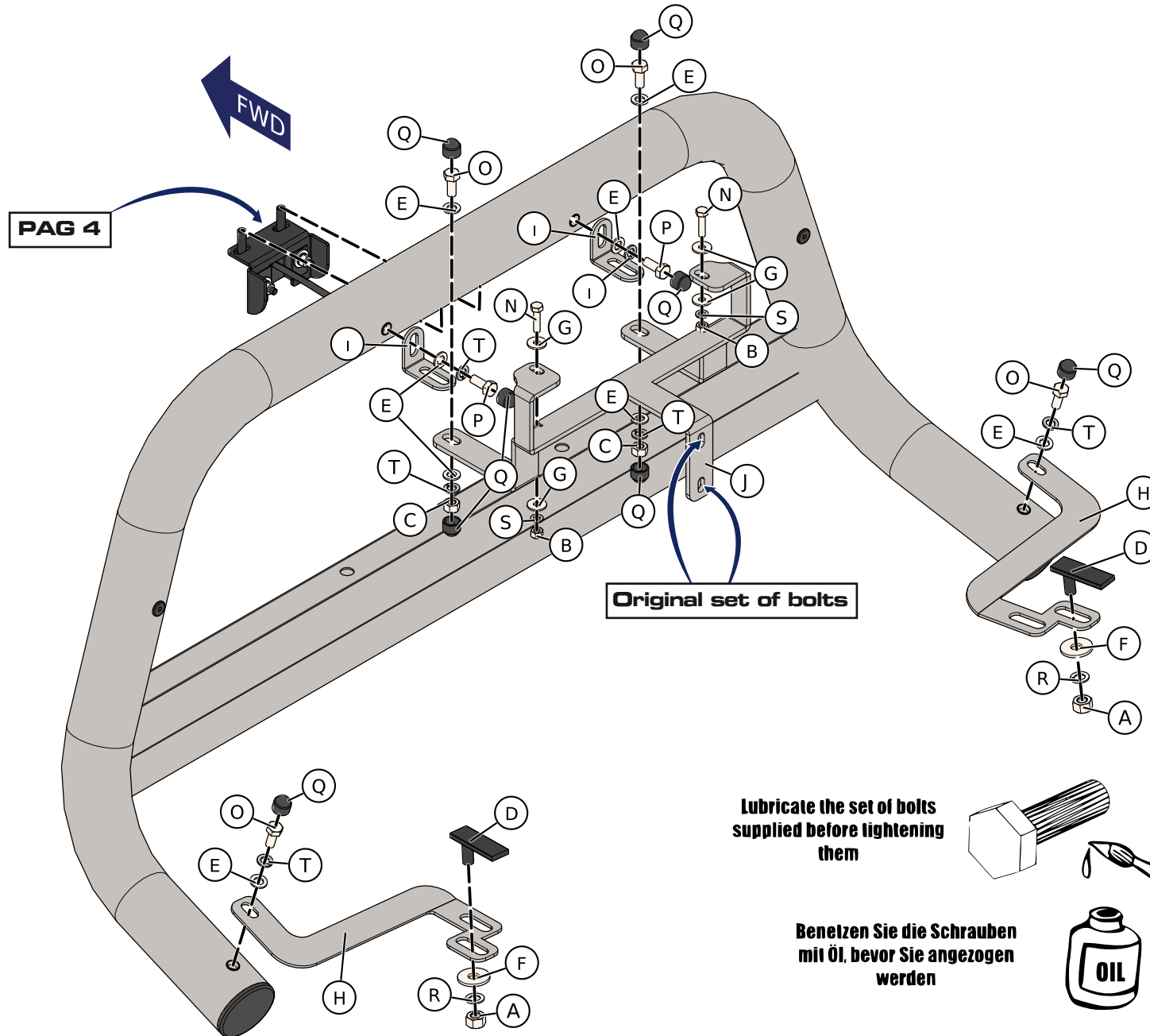

Lubricate the set of bolts  
supplied before tightening  
them

Benetzen Sie die Schrauben  
mit Öl, bevor Sie angezogen  
werden



Si consiglia di lubrificare  
la bulloneria in dotazione  
prima del serraggio

Lubrifier la boulonnerie  
avant de la serrer

# ISUZU D-MAX 2026

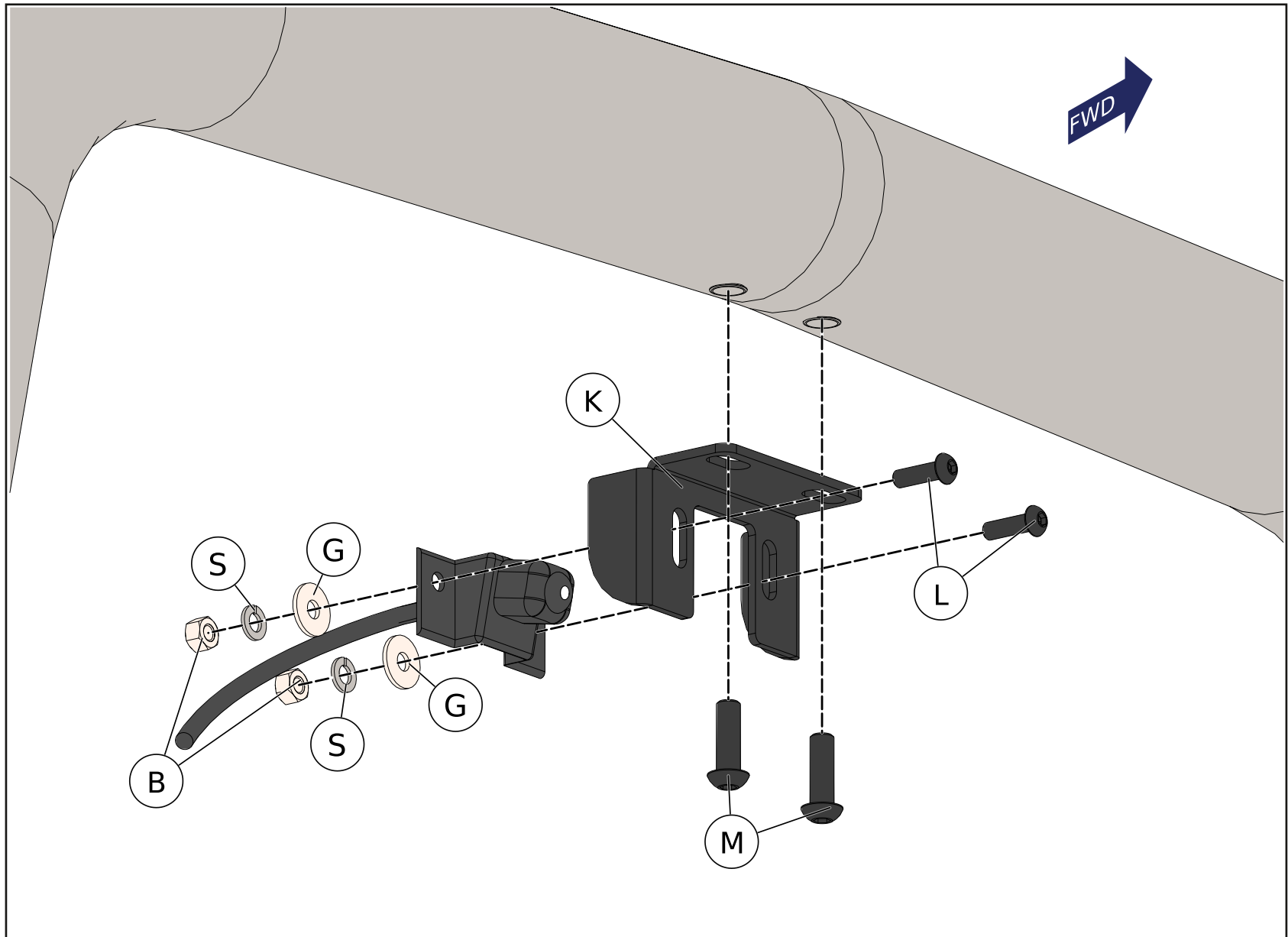



1



2



3



4

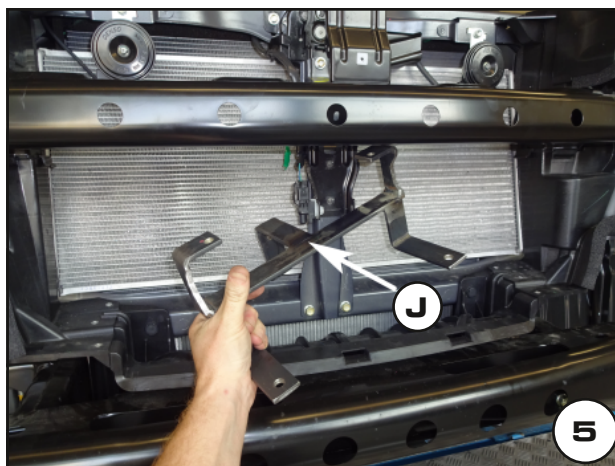

5

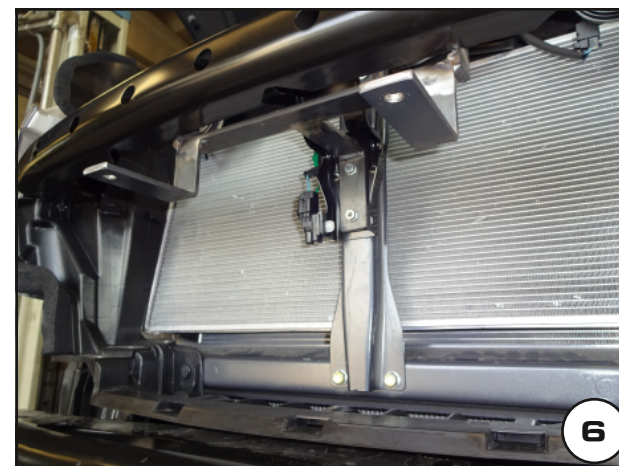

6

Date Data Date	Item Code Cod. Articolo Réf. Article	Vehicle model Modello Veicolo Modèle de Voiture
28/04/2026	EC/MED/560/PL	ISUZU D-MAX 2026

Document checked and approved by  
**Documento controllato ed approvato da**  
 Document contrôlé et approuvé par

**BOTTA PIETRO**

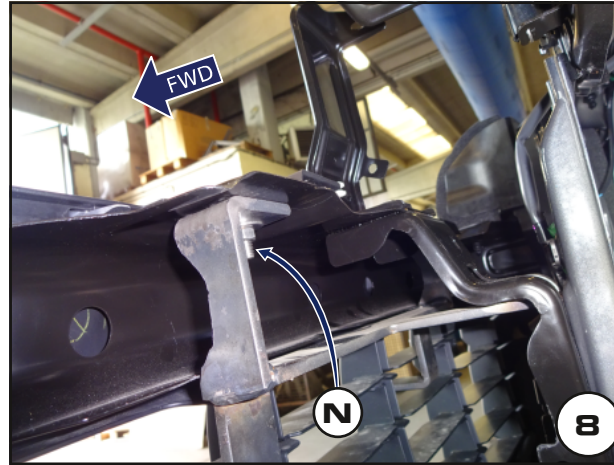
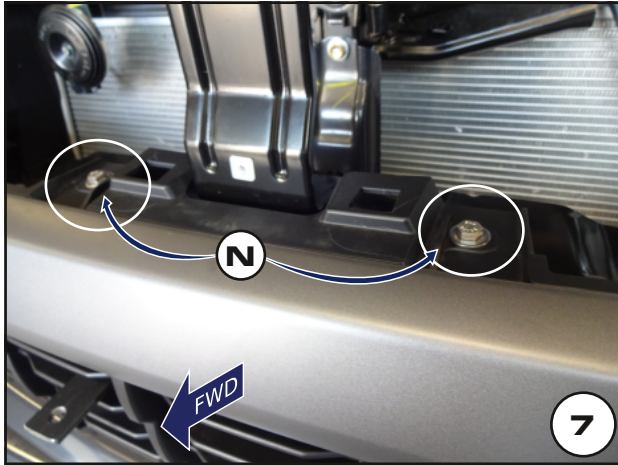

Date Data Date	Item Code Cod. Articolo Réf. Article	Vehicle model Modello Veicolo Modèle de Voiture
28/04/2026	EC/MED/560/PL	ISUZU D-MAX 2026

Document checked and approved by  
**Documento controllato ed approvato da**  
 Document contrôlé et approuvé par

**BOTTA PIETRO**

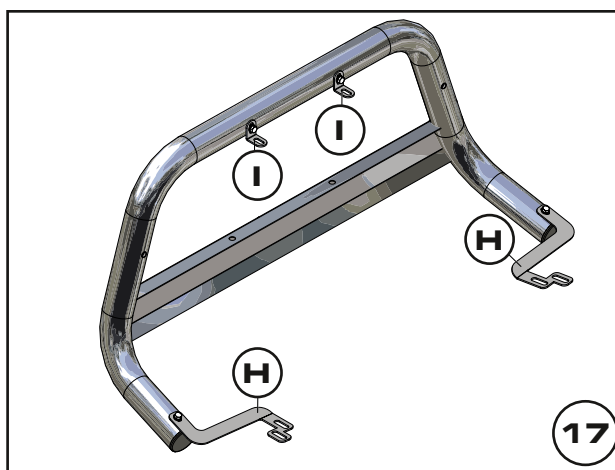
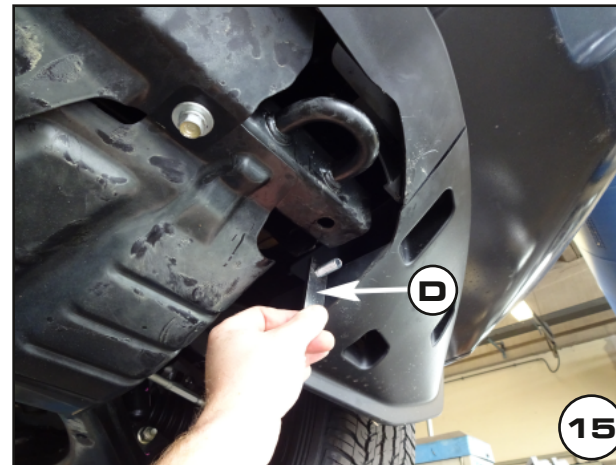

Date Data Date	Item Code <b>Cod. Articolo</b> Réf. Article	Vehicle model <b>Modello Veicolo</b> Modèle de Voiture
<b>28/04/2026</b>	<b>EC/MED/560/PL</b>	<b>ISUZU D-MAX 2026</b>

Document checked and approved by  
**Documento controllato ed approvato da**  
 Document contrôlé et approuvé par

**BOTTA PIETRO**



Date <b>Data</b> Date	Item Code <b>Cod. Articolo</b> Réf. Article	Vehicle model <b>Modello Veicolo</b> Modèle de Voiture
<b>28/04/2026</b>	<b>EC/MED/560/PL</b>	<b>ISUZU D-MAX 2026</b>

Document checked and approved by  
**Documento controllato ed approvato da**  
 Document contrôlé et approuvé par

**BOTTA PIETRO**