

MISUTONIDA
 italian style accessories **4x4**



NISSAN INTERSTAR 2025
RENAULT MASTER 2024



 **50 Min.**

Item Code **EC/MED/533/IX**
 Codice Articolo **EC/MED/532/IX**
 Référence Article **EC/MED/532/IX**







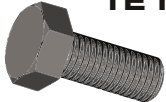

GB
 STAINLESS STEEL MEDIUM
 BAR

ITA
**MEDIUM BAR IN ACCIAIO
 INOX**

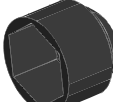
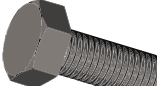
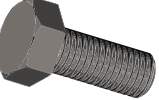
FR
 MEDIUM BAR EN ACCIER
 INOX

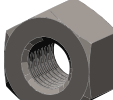
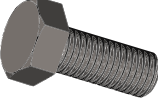
NISSAN INTERSTAR 2025

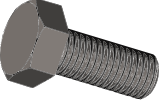
Part list
Lista Bulloneria
 Liste des pièces

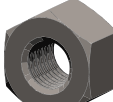
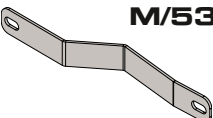
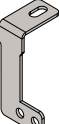
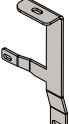
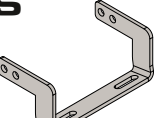
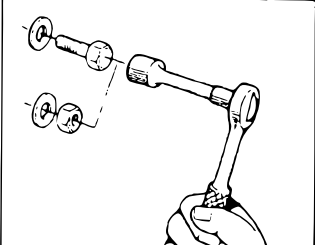
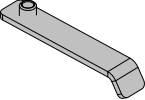
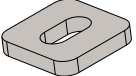
A  TE M8X20 x 8	B  Ø8 x 14	C  Ø8 x 12	D  M8 x 12	E  TE M8X25 x 2
F  TE M8X50 x 2	G  Big Grandi Grand Ø8 x 4	H  M8 x 6	I  TE M10X45 x 2	J  Big Grandi Grand Ø10 x 2
K  Ø10 x 2	L  TE M6X25 x 2	M  Big Grandi Grand Ø6 x 4	N  Ø6 x 2	O  M6 x 2
P  M/532/A x 2	Q  M/532/B x 2	R  SM/532/B x 2	S  SM/532/C x 2	 M6: 10 Nm M8: 25 Nm M10: 50 Nm M12: 87 Nm
T  SM/532/D x 2	U  SM/532/E x 2			



Approval Mark below the central plate

MISUTONIDA
 italian style accessories **4x4**

NISSAN INTERSTAR 2025

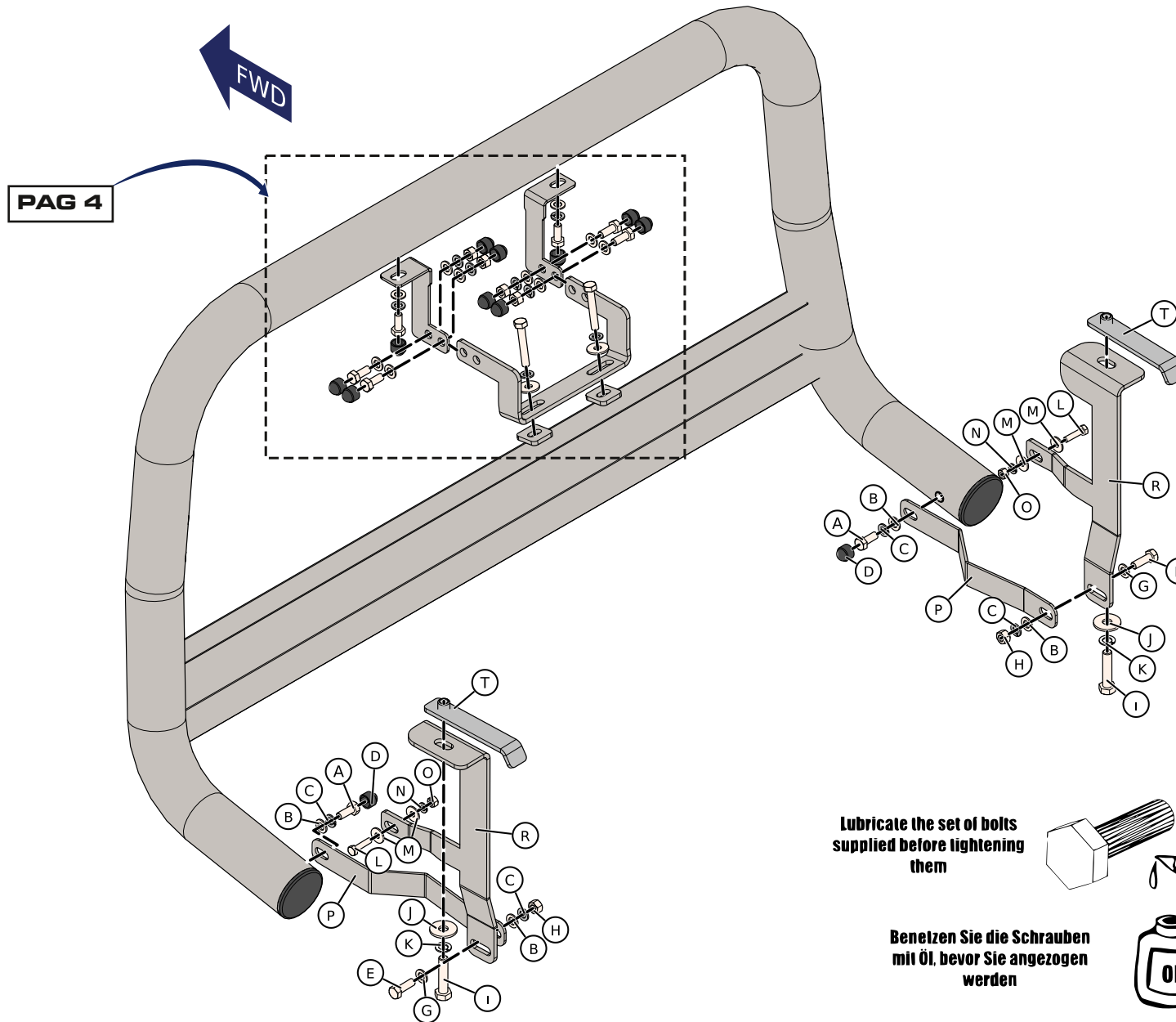

Lubricate the set of bolts supplied before tightening them

Benetzen Sie die Schrauben mit Öl, bevor Sie angezogen werden

Si consiglia di lubrificare la bulloneria in dotazione prima del serraggio

Lubrifier la boulonnerie avant de la serrer



NISSAN INTERSTAR 2025

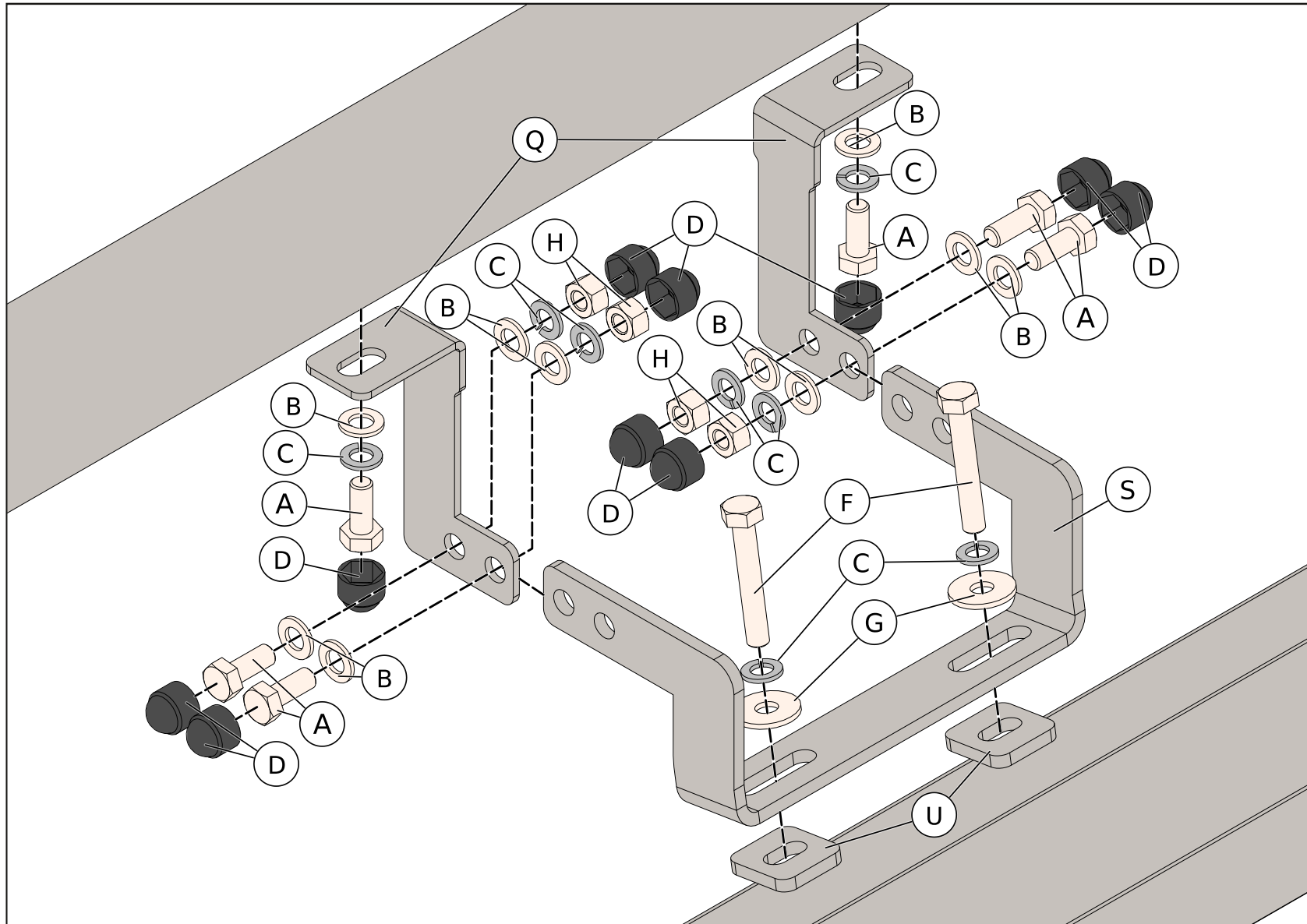

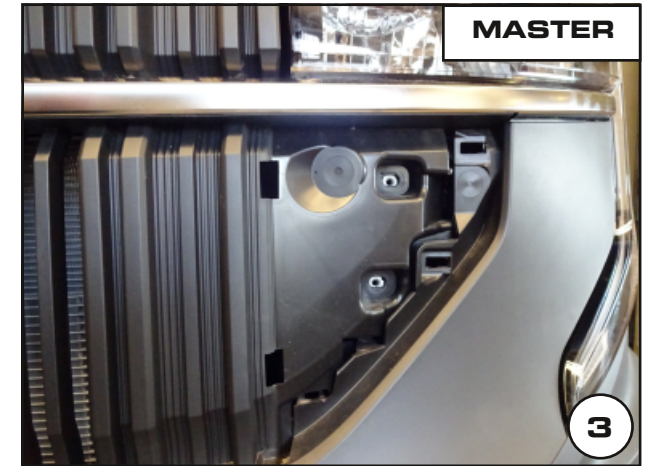
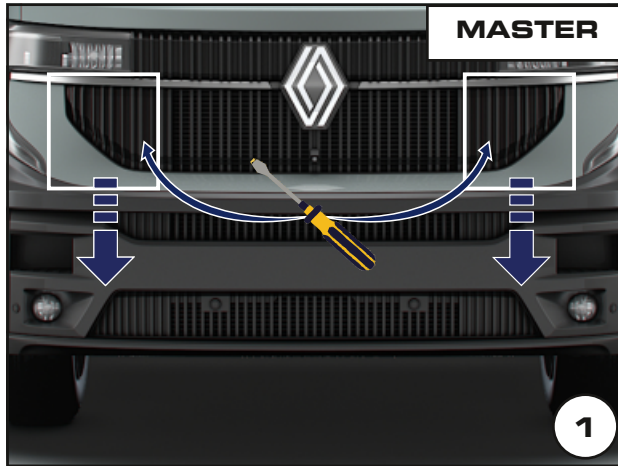

Date Data Date	Item Code Cod. Articolo Réf. Article	Vehicle model Modello Veicolo Modèle de Voiture
08/05/2026	EC/MED/533/IX EC/MED/532/IX	NISSAN INTERSTAR 2025 RENAULT MASTER 2024

Document checked and approved by
Documento controllato ed approvato da
 Document contrôlé et approuvé par

BOTTA PIETRO

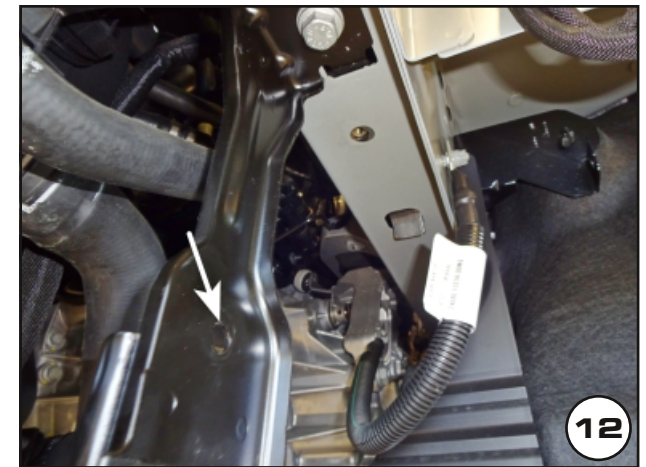
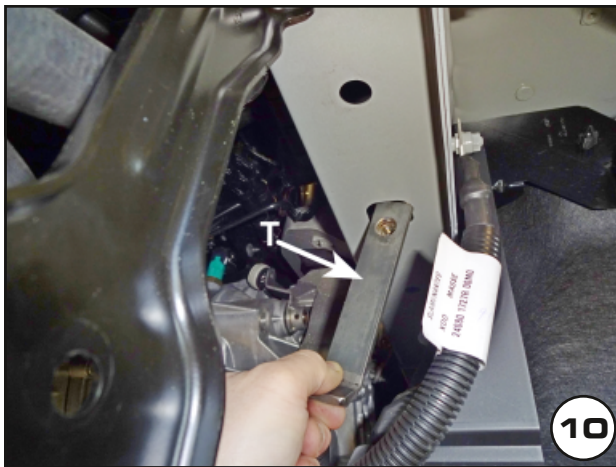
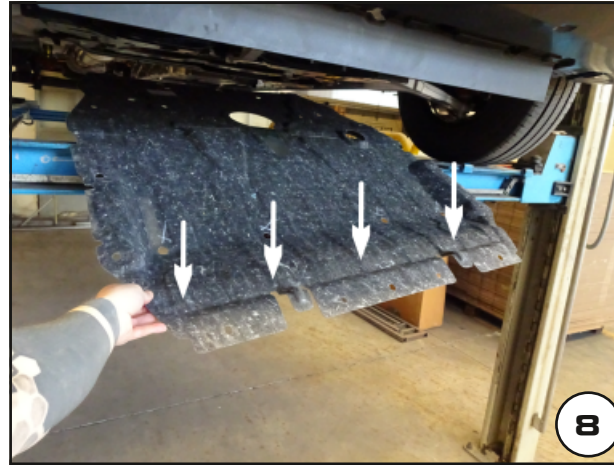

Date Data Date	Item Code Cod. Articolo Réf. Article	Vehicle model Modello Veicolo Modèle de Voiture
08/05/2026	EC/MED/533/IX EC/MED/532/IX	NISSAN INTERSTAR 2025 RENAULT MASTER 2024

Document checked and approved by
Documento controllato ed approvato da
 Document contrôlé et approuvé par

BOTTA PIETRO

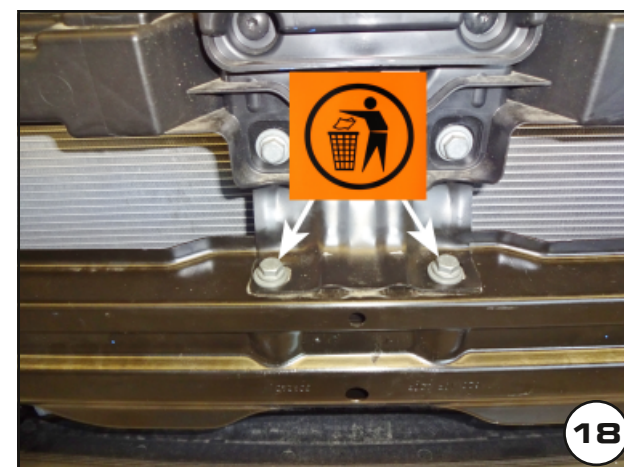
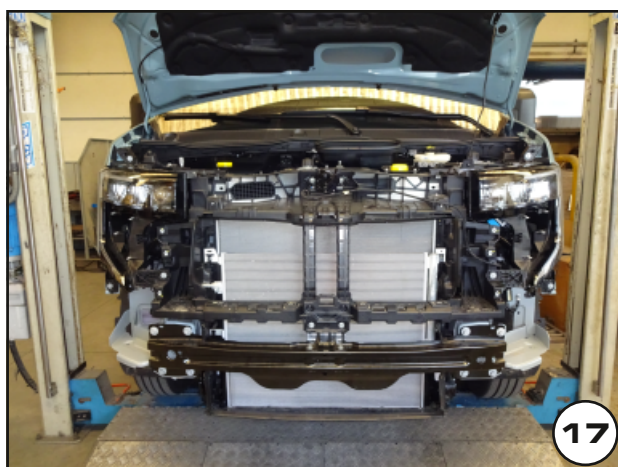
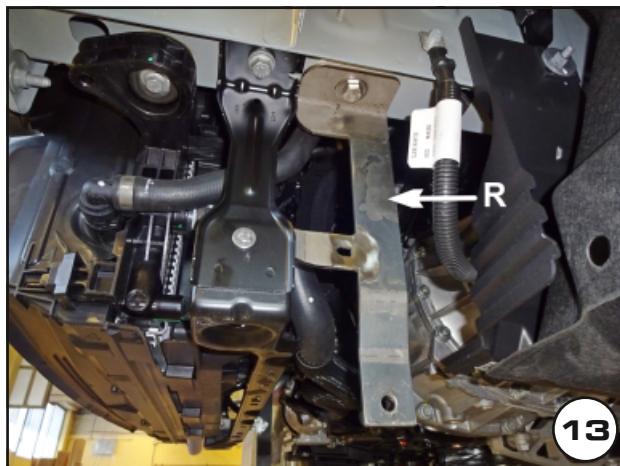

Date Data Date	Item Code Cod. Articolo Réf. Article	Vehicle model Modello Veicolo Modèle de Voiture
08/05/2026	EC/MED/533/IX EC/MED/532/IX	NISSAN INTERSTAR 2025 RENAULT MASTER 2024

Document checked and approved by
Documento controllato ed approvato da
 Document contrôlé et approuvé par

BOTTA PIETRO

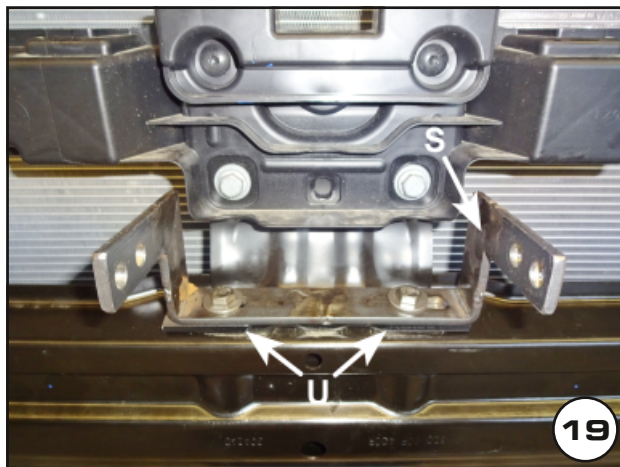

19



20



21



22



23

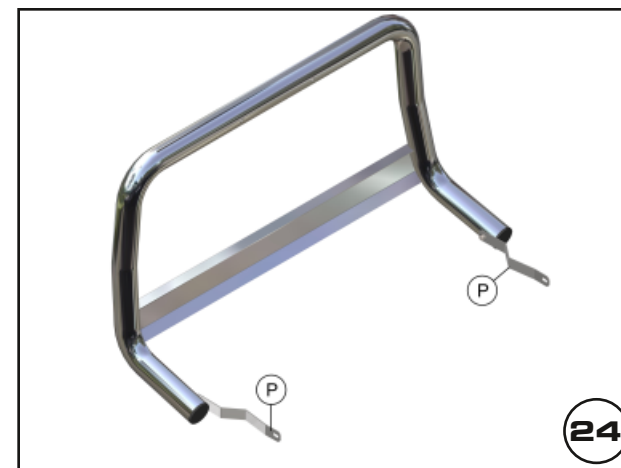

24

Date Data Date	Item Code Cod. Articolo Réf. Article	Vehicle model Modello Veicolo Modèle de Voiture
08/05/2026	EC/MED/533/IX EC/MED/532/IX	NISSAN INTERSTAR 2025 RENAULT MASTER 2024

Document checked and approved by
Documento controllato ed approvato da
 Document contrôlé et approuvé par

BOTTA PIETRO

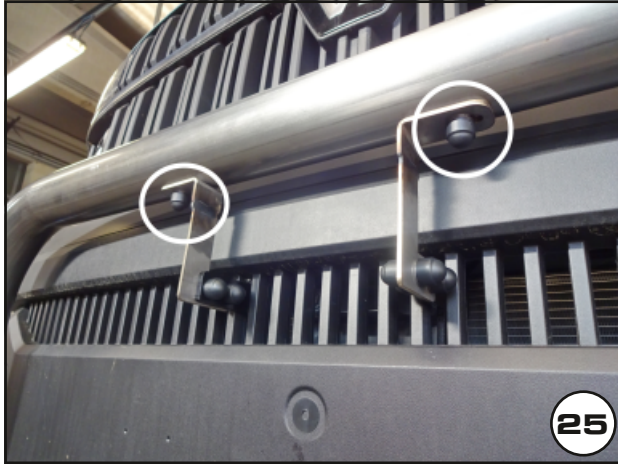

25



26



27



MASTER

28



INTERSTAR

29

Date Data Date	Item Code Cod. Articolo Réf. Article	Vehicle model Modello Veicolo Modèle de Voiture
08/05/2026	EC/MED/533/IX EC/MED/532/IX	NISSAN INTERSTAR 2025 RENAULT MASTER 2024

Document checked and approved by
Documento controllato ed approvato da
 Document contrôlé et approuvé par

BOTTA PIETRO