

Überrollbügel mit Gepäckträger für Jeep Gladiator



Vor der Montage

- Bitte lesen Sie sich diese Anleitung durch, bevor Sie mit der Montage beginnen um evtl. Beschädigungen am Fahrzeug zu vermeiden.
- Die Abbildungen dienen nur der Veranschaulichung und sehen ggf. Anders aus, als die Teile, die Sie erhalten haben. Die Art und Weise der Montage ist aber gleich.











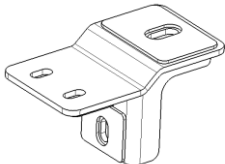
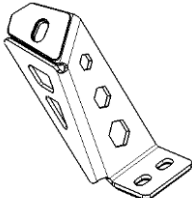
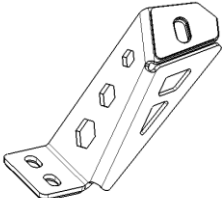
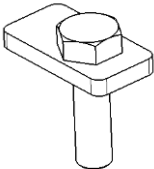
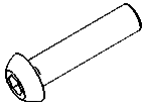
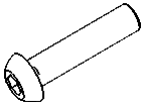

Pflege und Reinigung

- Milde Seife kann zur Reinigung verwendet werden. Bitte beachten Sie aber unbedingt den gesondert beiliegenden Pflegehinweis.
- Überprüfen Sie regelmäßig den korrekten Sitz des Bügels und ziehen Sie ggf. Schrauben nach.



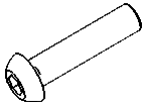



Teilleiste

Nr.	Stk.	Abbildung	Nr.	Stk.	Abbildung
1	1	A U-shaped pipe with a central horizontal section and two curved ends.	2	1	A curved pipe with a hook at one end and a flared end at the other.
		Hauptrohr			Seitenrohr (L)
3	1	A curved pipe with a hook at one end and a flared end at the other, mirror image of part 2.	4	1	A trapezoidal plate with three horizontal slots and several holes.
		Seitenrohr (R)			Abdeckplatte 1 (L)
5	1	A trapezoidal plate with three horizontal slots and several holes, mirror image of part 4.	6	1	A long, thin rectangular plate with a raised edge on one side and several holes.
		Abdeckplatte 1 (R)			Abdeckplatte 2
7	1	A long, thin rectangular plate with a raised edge on one side and several holes, mirror image of part 6.	7	2	A simple rectangular plate with two circular holes at opposite ends.
		Abdeckplatte 2			Kunststoffplatte 3
9	1	A long, thin base with a series of raised rectangular sections.	10	1	A long, thin base with a series of raised rectangular sections, mirror image of part 9.
		Montage Basis (L)			Montage Basis (R)
11	A small, circular rubber stop with a central hole.	12	2	A circular rubber cover with a raised rim.	
		Gummistopfen			Gummi Abdeckung 1
13	2	A circular rubber cover with a raised rim, mirror image of part 12.	14	1	A rectangular carrier with a mesh bottom and raised sides.
		Gummi Abdeckung 2			Gepäckträger

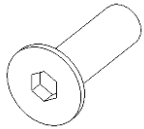
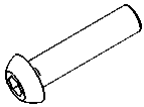
Montageanleitung - Art. 10110 Stand: 23.03.2022

15	2	 Halterung Vorne	16	1	 Halterung Hinten (L)
17	1	 Halterung Hinten (R)	18	6	 T-Bolzen M10*30
19	8	 Innensechskantschraube M6-15	20	16	 Innensechskantschraube M6-20
21	8	 U-Scheibe flach D6	22	32	 U-Scheibe groß D6
23	16	 Federring D6	24	16	 Mutter M6
25	8	 Sicherungsmutter M6	26	14	 Montageschraube M8-25
27	4	 U-Scheibe groß D8	28	4	 Mutter M8
29	2	 Innensechskantschraube M10-25	30	8	 Federring D10
31	6	 U-Scheibe groß D10	32	2	 U-Scheibe flach D10

Montageanleitung - Art. 10110 Stand: 23.03.2022

33	6	 Mutter M10	34	2	 Innensechskantschraube M12-40
35	2	 Innensechskantschraube M12-40	36	2	 U-Scheibe flach D12
37	2	 Federring D12	38	1	 Innensechskantschlüssel S=4
39	1	 Innensechskantschlüssel S=5	40	1	 Innensechskantschlüssel S=6
41	1	 Innensechskantschlüssel S=8			

Montageschritte

Montageskizze

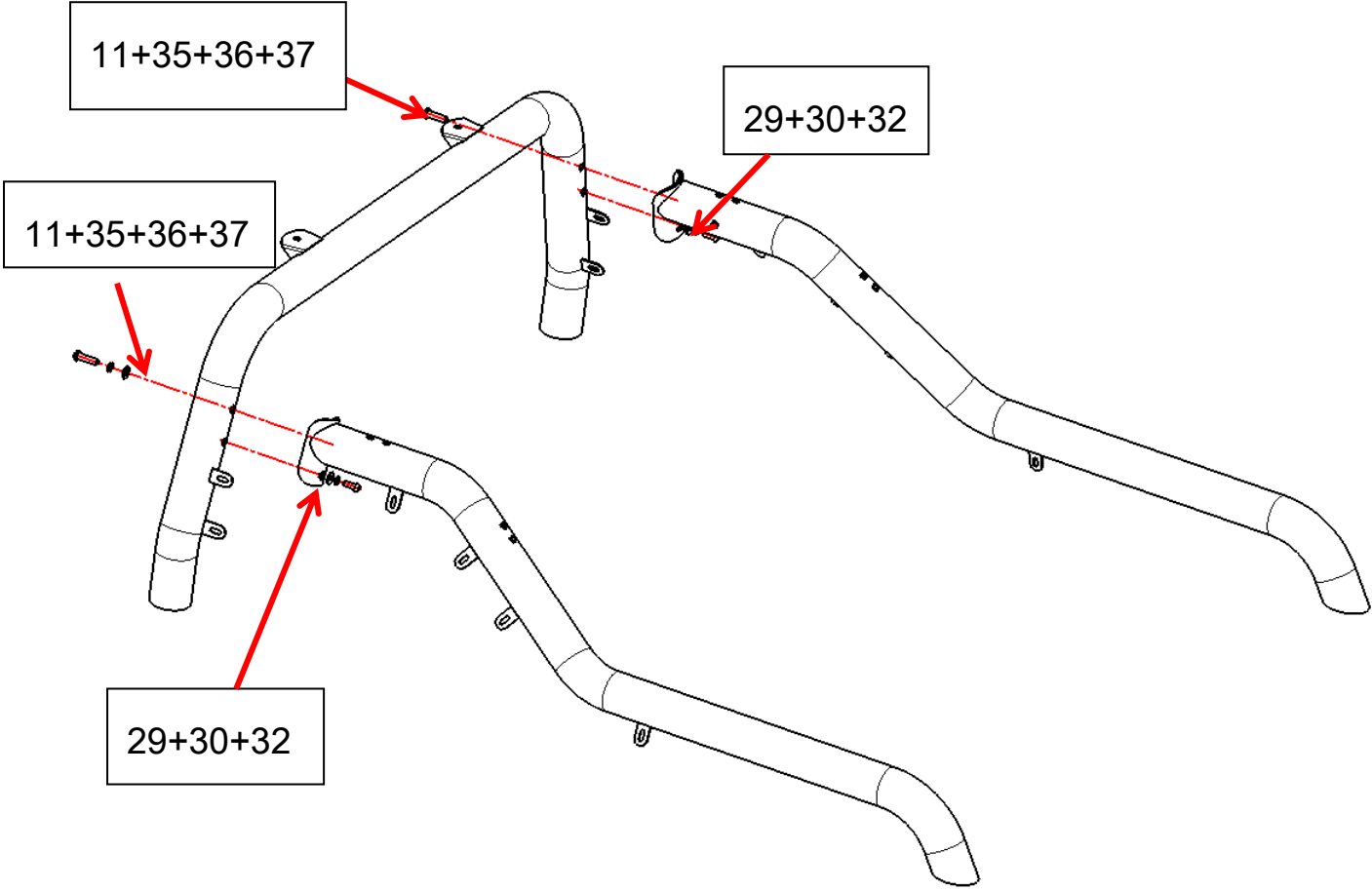

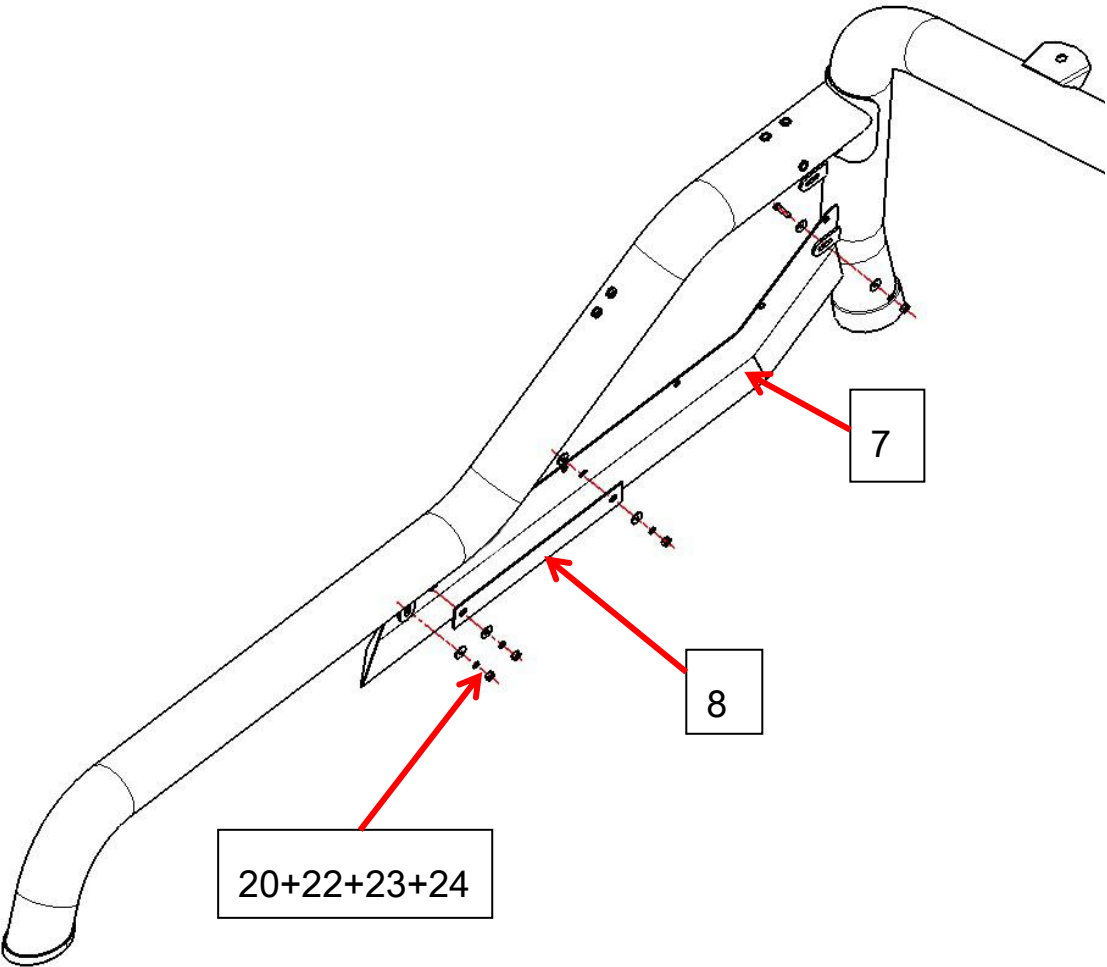
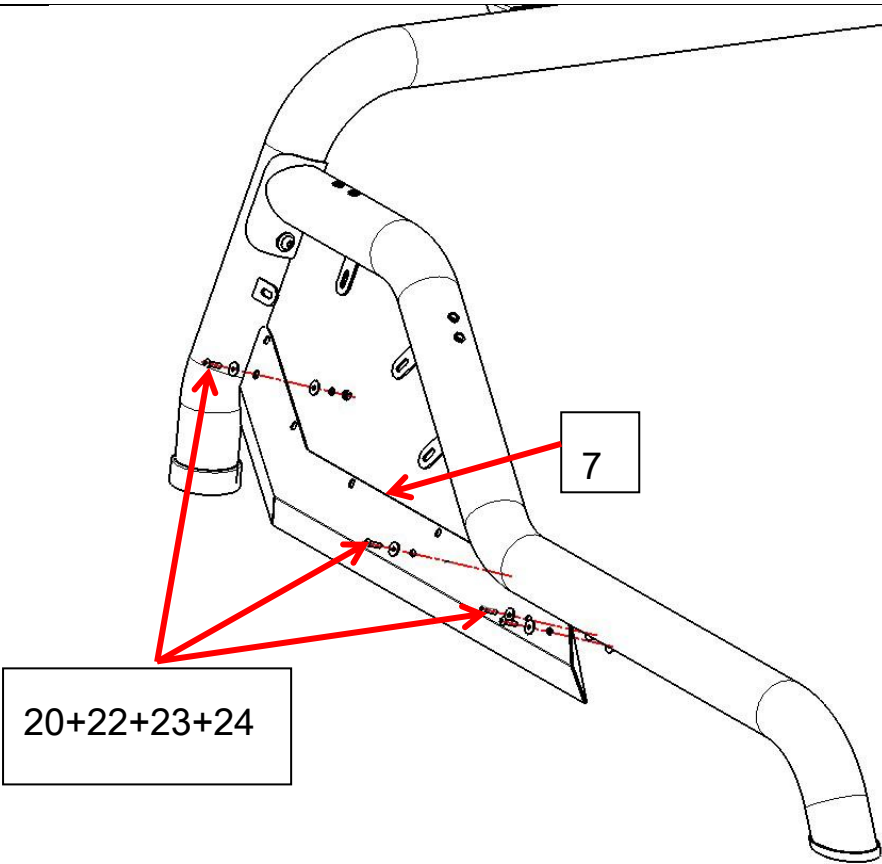

20+22+23+24

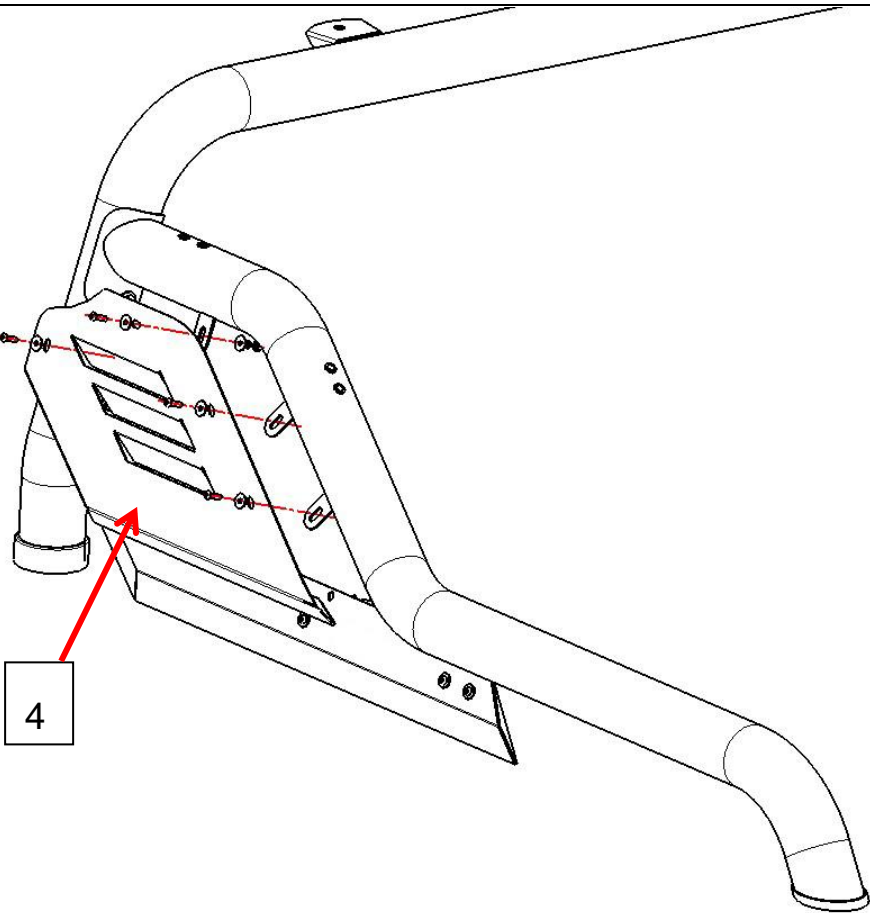

20+22+23+24

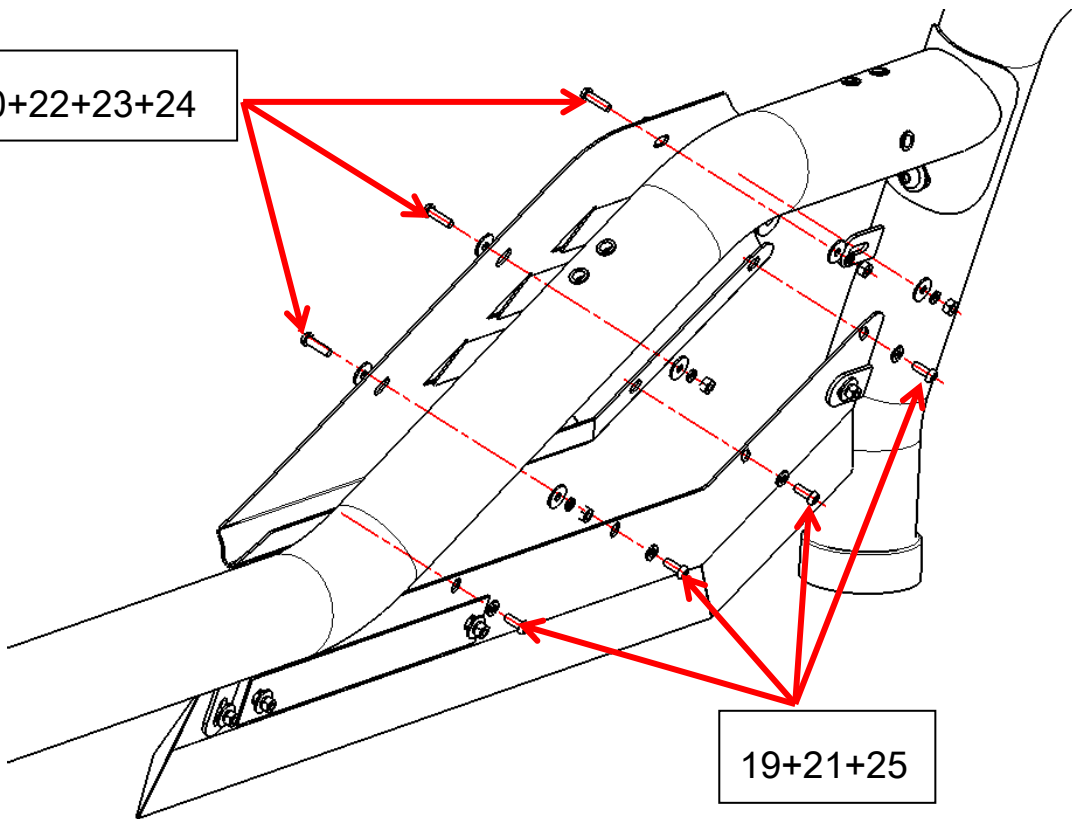

19+21+25

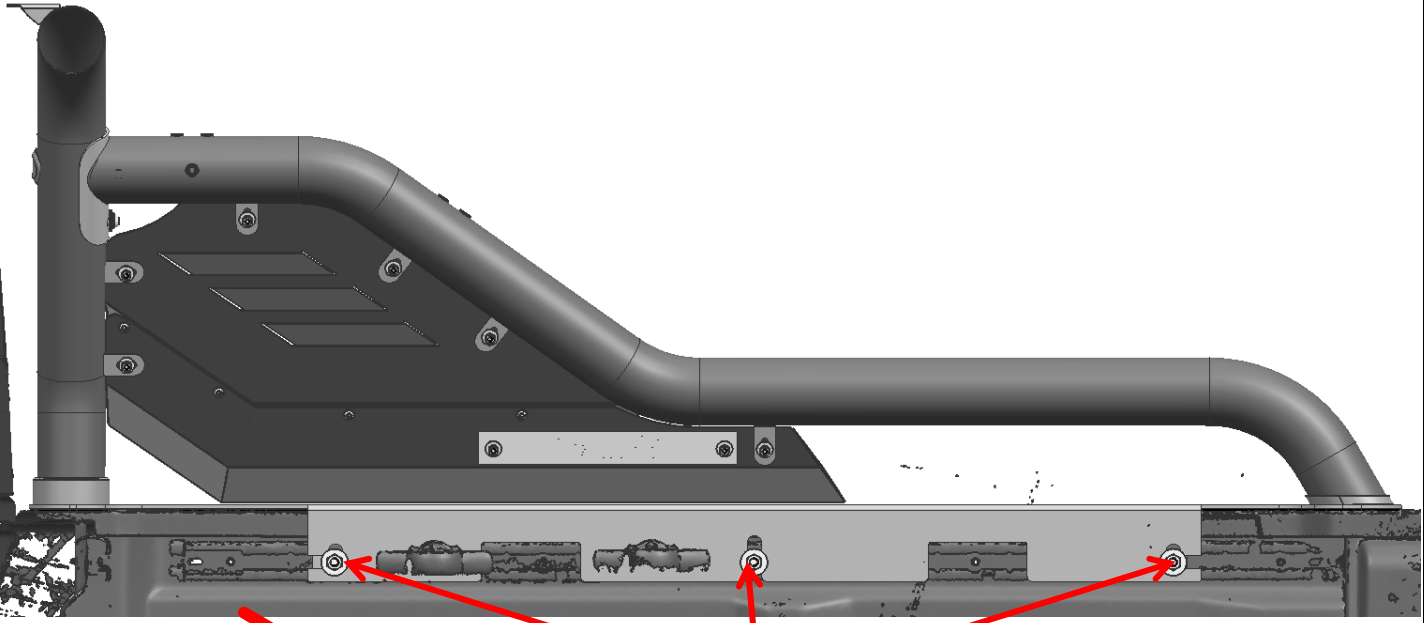
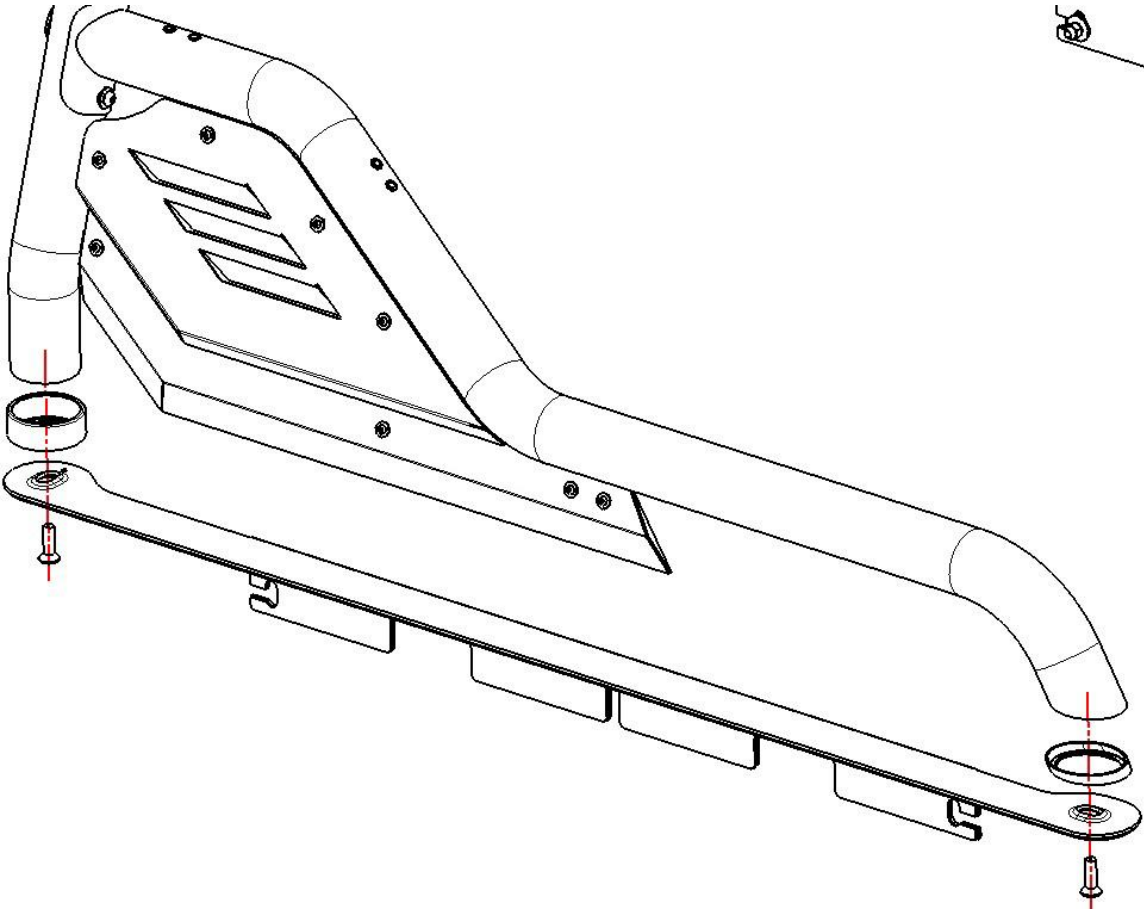

18+30+31+33

